

BiPAC 7402VL/VGL/VGP

VoIP/(802.11g) ADSL2+ Router

User's Manual

Table of Contents

CHAPTER 1: INTRODUCTION	3
INTRODUCTION TO YOUR ROUTER	3
MODELS	3
FEATURES.....	3
CHAPTER 2: INSTALLING THE ROUTER.....	6
IMPORTANT NOTE FOR USING THIS ROUTER	6
PACKAGE CONTENTS	6
THE FRONT LEADS.....	7
THE REAR PORTS.....	8
CABLING.....	10
CHAPTER 3: BASIC INSTALLATION	11
CONNECTING YOUR ROUTER.....	12
FACTORY DEFAULT SETTINGS	17
<i>Web Interface (Username and Password)</i>	17
<i>LAN Device IP Settings</i>	17
<i>ISP setting in WAN site</i>	17
<i>DHCP server</i>	17
<i>LAN and WAN Port Addresses</i>	17
INFORMATION FROM YOUR ISP.....	18
CONFIGURING WITH YOUR WEB BROWSER.....	19
CHAPTER 4: CONFIGURATION	20
STATUS.....	21
<i>ARP Table</i>	21
<i>Wireless Association Table (7402VGL/VGP only)</i>	21
<i>DHCP Table</i>	23
<i>Email Status</i>	24
<i>VoIP Status</i>	24
<i>Event Log</i>	24
<i>Error Log</i>	25
<i>NAT Sessions</i>	25
<i>UPnP Portmap</i>	25
QUICK START	26
CONFIGURATION.....	28
<i>LAN (Local Area Network)</i>	28
Ethernet.....	28
Ethernet Client Filter	29
Wireless (7402VGL/VGP only)	31
Wireless Security (7402VGL/VGP only).....	33
Wireless Client (MAC Address) Filter (7402VGL/VGP only).....	35
DHCP Server	37
<i>WAN (Wide Area Network)</i>	38
ISP	38
DNS	48
ADSL.....	49
<i>System</i>	50
Time Zone	50
Remote Access	51

Firmware Upgrade.....	52
Backup / Restore.....	53
Restart Router.....	54
User Management.....	55
<i>Firewall and Access Control</i>	56
General Settings.....	57
Packet Filter.....	58
Intrusion Detection.....	65
URL Filter.....	67
Firewall Log.....	70
<i>VoIP (Voice over Internet Protocol)</i>	71
Wizard.....	72
General Configuration.....	73
Phone Configuration.....	75
PSTN Dial Plan (7402VGP only).....	77
Special dial codes.....	79
<i>QoS (Quality of Service)</i>	80
Prioritization.....	81
Outbound IP Throttling (LAN to WAN).....	83
Inbound IP Throttling (WAN to LAN).....	84
<i>Virtual Server (“Port Forwarding”)</i>	88
Add Virtual Server.....	89
Edit DMZ Host.....	91
Edit One-to-One NAT (Network Address Translation).....	92
<i>Time Schedule</i>	95
Configuration of Time Schedule.....	96
<i>Advanced</i>	97
Static Route.....	97
Dynamic DNS.....	98
Check Email.....	99
Device Management.....	100
IGMP.....	104
SAVE CONFIGURATION TO FLASH.....	105
LOGOUT.....	106
CHAPTER 5: TROUBLESHOOTING	107
PROBLEMS STARTING UP THE ROUTER.....	107
PROBLEMS WITH THE WAN INTERFACE.....	107
PROBLEMS WITH THE LAN INTERFACE.....	108
APPENDIX A: PRODUCT SUPPORT AND CONTACT INFORMATION	109

Chapter 1: Introduction

Introduction to your Router

Welcome to the VoIP/(802.11g) ADSL2+ Router. The router is an “all-in-one” VoIP ADSL router, combining an ADSL modem, ADSL router, Ethernet network switch and 2 ports for Voice over IP functionalities, providing everything you need to get the machines on your network connected to the Internet over your ADSL broadband connection. With features such as an ADSL Quick-Start wizard and DHCP Server, you can be online in no time at all and with a minimum of fuss and configuration, catering for first-time users to the guru requiring advanced features and control over their Internet connection and network.

Models

- BiPAC 7402VL: VoIP ADSL Router **(with 2FXS port)**
- BiPAC 7402VGL: VoIP/802.11g ADSL Router **(with 2FXS port and Wireless-G)**
- BiPAC 7402VGP: VoIP/802.11g ADSL Router with LINE port **(with 2FXS/1FXO port and Wireless-G)**

Features

- **Voice over IP compliance with SIP standard**

The router supports cost-effective, toll-quality voice calls over the Internet. It complies with the most popular industrial standard, SIP protocol, to ensure the interoperability with SIP devices and major VoIP Gateways. The VoIP ADSL router supports call waiting, silence suppression, voice activity detection (VAD), comfort noise generation (CNG), line echo cancellation, caller ID (Bell 202, V3) and so on.
- **Lifeline Support (7402VGP only)**

The router integrates RJ-11 FXO port for inbound and outbound calls transmitted through PSTN. Users can receive phone calls from PSTN while enjoying VoIP call service at the same time. In addition, the device automatically fallbacks to lifeline POTS to enable making normal phone calls when there is power outage, or when the Internet connection is down.
- **Express Internet Access – capable of ADSL2/2+**

The router complies with ADSL worldwide standards. It supports downstream rates up to 8Mbps with ADSL, capable of up to 12/24 Mbps with ADSL2/2+, and upstream rates up to 1 Mbps. Users enjoy not only high-speed ADSL services but also broadband multimedia applications such as interactive gaming, video streaming and real-time audio much easier and faster than ever. It is compliant with Multi-Mode standard (ANSI T1.413, Issue 2; G.dmt (ITU G.992.1); G.hs (ITU G.994.1); G.dmt.bis (ITU G.992.3); G.dmt.bisplus (ITU G.992.5)).
- **802.11g Wireless AP with WPA Support**

With integrated 802.11g Wireless Access Point in the router, the device offers a quick and easy access among wired network, wireless network and broadband connection (ADSL) with single device simplicity, and as a result, mobility to the users. In addition to 54 Mbps 802.11g data rate, it also interoperates backward with existing 802.11b equipment. The Wireless Protected Access (WPA) and Wireless Encryption Protocol (WEP) supported features enhance the security level of data protection and access control via Wireless LAN.
- **Fast Ethernet Switch**

A 3-port 10/100Mbps fast Ethernet switch is built in with automatic switching between MDI and MDI-X for 10Base-T and 100Base-TX ports. An Ethernet straight or crossover cable can be used directly for auto detection.

- **Multi-Protocol to Establish A Connection**

Supports PPPoA (RFC 2364 - PPP over ATM Adaptation Layer 5), RFC 1483 encapsulation over ATM (bridged or routed), PPP over Ethernet (RFC 2516), and IPoA (RFC1577) to establish a connection with the ISP. The product also supports VC-based and LLC-based multiplexing.
- **Quick Installation Wizard**

Supports a WEB GUI page to install this device quickly. With this wizard, end users can enter the information easily which they get from their ISP, then surf the Internet immediately.
- **Universal Plug and Play (UPnP) and UPnP NAT Traversal**

This protocol is used to enable simple and robust connectivity among stand-alone devices and PCs from many different vendors. It makes network simple and affordable for users. UPnP architecture leverages TCP/IP and the Web to enable seamless proximity networking in addition to control and data transfer among networked devices. With this feature enabled, users can now connect to Net meeting or MSN Messenger seamlessly.
- **Network Address Translation (NAT)**

Allows multi-users to access outside resources such as the Internet simultaneously with one IP address/one Internet access account. Many application layer gateway (ALG) are supported such as web browser, ICQ, FTP, Telnet, E-mail, News, Net2phone, Ping, NetMeeting, IP phone and others.
- **SOHO Firewall Security with DoS and SPI**

Along with the built-in NAT natural firewall feature, the router also provides advanced hacker pattern-filtering protection. It can automatically detect and block Denial of Service (DoS) attacks. The router is built with Stateful Packet Inspection (SPI) to determine if a data packet is allowed through the firewall to the private LAN.
- **Domain Name System (DNS) relay**

Provides an easy way to map the domain name (a friendly name for users such as www.yahoo.com) and IP address. When a local machine sets its DNS server with this router's IP address, every DNS conversion request packet from the PC to this router will be forwarded to the real DNS in the outside network.
- **Dynamic Domain Name System (DDNS)**

The Dynamic DNS service allows you to alias a dynamic IP address to a static hostname. This dynamic IP address is the WAN IP address. For example, to use the service, you must first apply for an account from a DDNS service like <http://www.dyndns.org/>. More than 5 DDNS servers are supported.
- **Quality of Service (QoS)**

QoS gives you full control over which types of outgoing data traffic should be given priority by the router, ensuring important data like gaming packets, customer information, or management information move through the router at lightning speed, even under heavy load. The QoS features are configurable by source IP address, destination IP address, protocol, and port. You can throttle the speed at which different types of outgoing data pass through the router, to ensure P2P users don't saturate upload bandwidth, or office browsing doesn't bring client web serving to a halt. In addition, or alternatively, you can simply change the priority of different types of upload data and let the router sort out the actual speeds.
- **Virtual Server ("port forwarding")**

Users can specify some services to be visible from outside users. The router can detect incoming service requests and forward either a single port or a range of ports to the specific local computer to handle it. For example, a user can assign a PC in the LAN acting as a WEB server inside and expose it to the outside network. Outside users can browse inside web servers directly while it is

protected by NAT. A DMZ host setting is also provided to a local computer exposed to the outside network, Internet.

- **Rich Packet Filtering**
Not only filters the packet based on IP address, but also based on Port numbers. It will filter packets from and to the Internet, and also provides a higher level of security control.
- **Dynamic Host Configuration Protocol (DHCP) client and server**
In the WAN site, the DHCP client can get an IP address from the Internet Service Provider (ISP) automatically. In the LAN site, the DHCP server can allocate a range of client IP addresses and distribute them including IP address, subnet mask as well as DNS IP address to local computers. It provides an easy way to manage the local IP network.
- **Static and RIP1/2 Routing**
Supports an easy static routing table or RIP1/2 routing protocol to support routing capability.
- **Simple Network Management Protocol (SNMP)**
It is an easy way to remotely manage the router via SNMP.
- **Web based GUI**
Supports web based GUI for configuration and management. It is user-friendly and comes with on-line help. It also supports remote management capability for remote users to configure and manage this product.
- **Firmware Upgradeable**
Device can be upgraded to the latest firmware through the WEB based GUI.
- **Rich management interfaces**
Supports flexible management interfaces with local console port, LAN port, and WAN port. Users can use terminal applications through the console port to configure and manage the device, or Telnet, WEB GUI, and SNMP through LAN or WAN ports to configure and manage the device.

Chapter 2: Installing the Router

Important note for using this router



Warning

- ✓ Do not use this router in high humidity or high temperatures.
- ✓ Do not use the same power source for this router as other equipment.
- ✓ Do not open or repair the case yourself. If this router is too hot, turn off the power immediately and have it repaired at a qualified service center.
- ✓ Avoid using this product and all accessories outdoors.



Attention

- ✓ Place this router on a stable surface.
- ✓ Only use the power adapter that comes with the package. Using a different voltage rating power adaptor may damage this router.

Package Contents

- VoIP/(802.11g) ADSL2 Router
- CD-ROM containing the online manual
- RJ-11 ADSL/telephone Cable
- Ethernet (CAT-5 LAN) Cable
- Console (PS2-RS232) Cable
- AC-DC power adapter (12VDC, 1.2A)
- Quick Start Guide

The Front LEDs

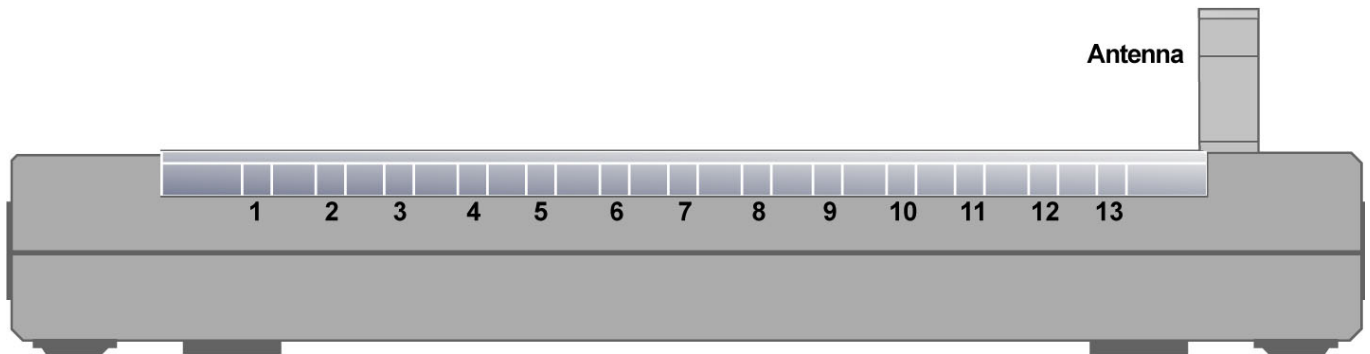

LED		Meaning
1	PWR	Lit when power is ON.
2	SYS	Lit when the system is ready.
3 - 5	LAN Port 1X — 3X (RJ-45 connector)	Lit when connected to an Ethernet device. Green for 100Mbps; Orange for 10Mbps. Blinking when data is Transmitted / Received.
7	WLAN (7402VGL/VGP only)	Lit green when the wireless connection is established. Flashes when sending/receiving data.
8 - 9	Phone 1X — 2X (RJ-11 connector)	Lit green when the phone is off-hook.
10	LINE (7402VGP only)	Lit when the inbound and outbound calls transmitted through PSTN.
11	VoIP	Lit when SIP registration is OK.
12	PPP / MAIL	Lit steady when there is a PPPoA / PPPoE connection. Lit and flashed periodically when there is email in the Inbox.
13	ADSL	Lit when successfully connected to an ADSL DSLAM ("linesync").

The Rear Ports

7402VL

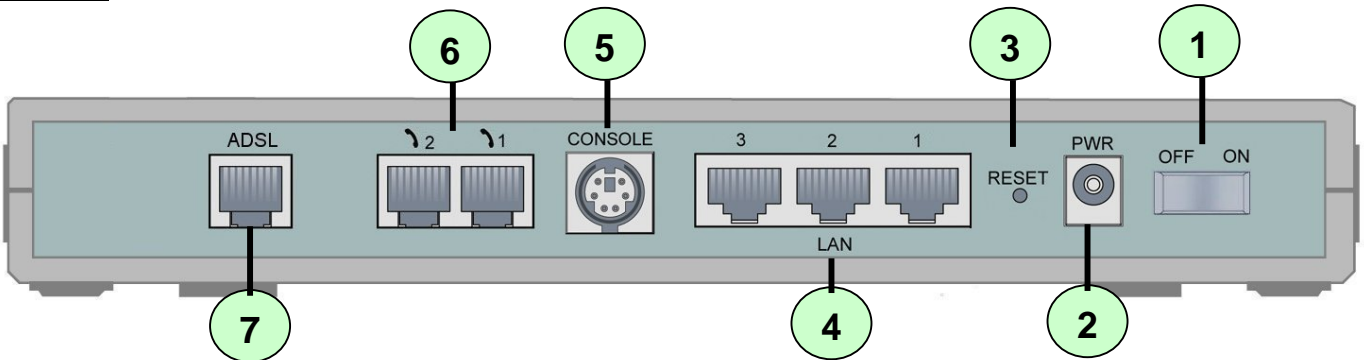

7402VGL

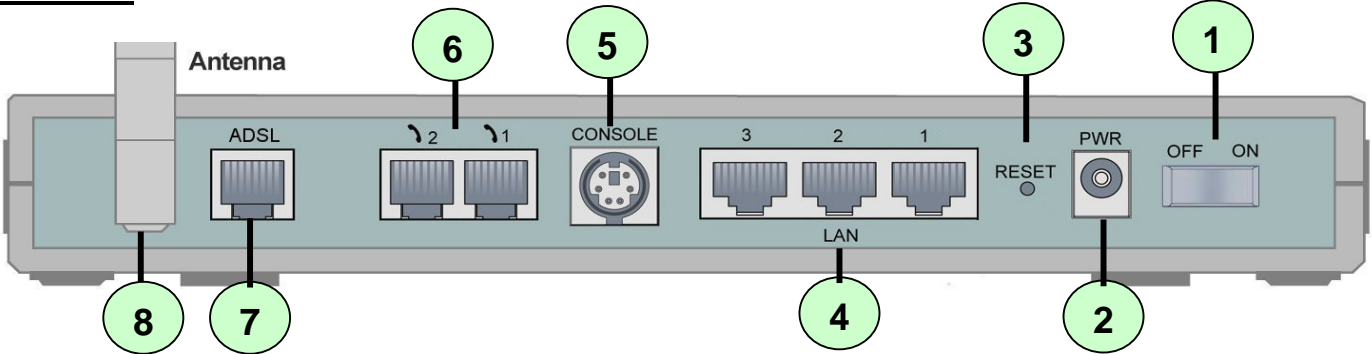

7402VGP

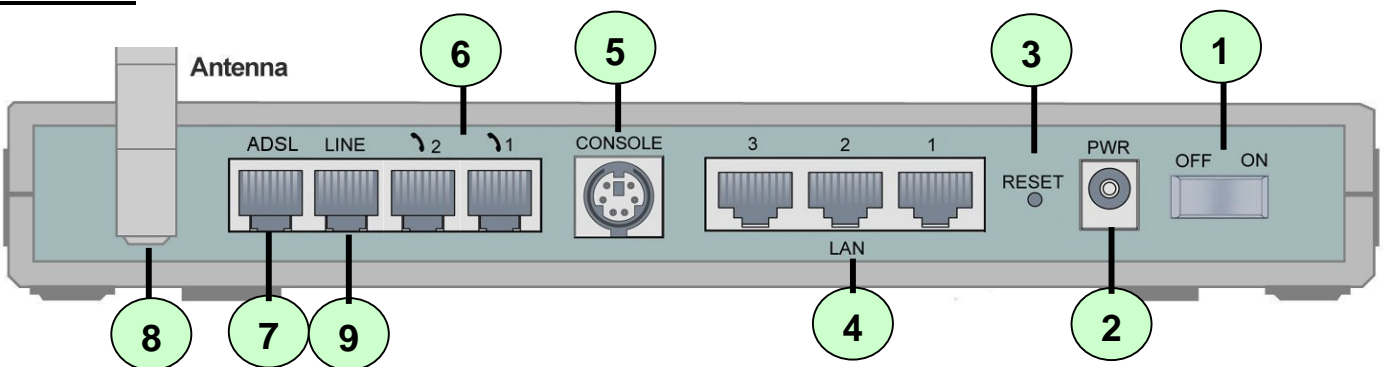

Port		Meaning
1	Power Switch	Power ON/OFF switch
2	PWR	Connect the supplied power adapter to this jack.
3	RESET	After the device is powered on, press it to reset the device or restore to factory default settings. 0-3 seconds: reset the device 6 seconds above: restore to factory default settings (this is used when you can not login to the router, e.g. forgot the password)
4	LAN 1X — 3X (RJ-45 connector)	Connect a UTP Ethernet cable (Cat-5 or Cat-5e) to one of the four LAN ports when connecting to a PC or an office/home network of 10Mbps or 100Mbps.
5	CONSOLE	Connect a PS2/RS-232 cable to this port when connecting to a PC's RS-232 port (9-pin serial port).
6	Phone 1X — 2X (RJ-11 connector)	Connect RJ-11 cable to this port when connecting to an analog phone set.
7	ADSL	Connect the supplied RJ-11 ("telephone") cable to this port when connecting to the ADSL/telephone network.
8	Antenna (7402VGL/VGP only)	Connect the detachable antenna to this port.
9	LINE (7402VGP only)	Connect RJ-11 cable to this port when connecting to the telephone wall jack.

Cabling

One of the most common causes of problems is bad cabling or ADSL line(s). Make sure that all connected devices are turned on. On the front of the product is a bank of LEDs. Verify that the LAN Link and ADSL line LEDs are lit. If they are not, verify that you are using the proper cables.

Ensure that all other devices connected to the same telephone line as your router (e.g. telephones, fax machines, analogue modems) have a line filter connected between them and the wall socket (unless you are using a Central Splitter or Central Filter installed by a qualified and licensed electrician), and ensure that all line filters are correctly installed and the right way around. Missing line filters or line filters installed the wrong way around can cause problems with your ADSL connection, including causing frequent disconnections.

Chapter 3: Basic Installation

The router can be configured with your web browser. A web browser is included as a standard application in the following operating systems: Linux, Mac OS, Windows 98/NT/2000/XP/Me, etc. The product provides a very easy and user-friendly interface for configuration.

PCs must have an Ethernet interface installed properly and be connected to the router either directly or through an external repeater hub, and have TCP/IP installed and configured to obtain an IP address through a DHCP server or a fixed IP address that must be in the same subnet as the router. The default IP address of the router is **192.168.1.254** and the subnet mask is **255.255.255.0** (i.e. any attached PC must be in the same subnet, and have an IP address in the range of 192.168.1.1 to 192.168.1.253). The best and easiest way is to configure the PC to get an IP address automatically from the router using DHCP. If you encounter any problems accessing the router's web interface it may also be advisable to **uninstall** any kind of software firewall on your PCs, as they can cause problems accessing the 192.168.1.254 IP address of the router. Users should make their own decisions on how to best protect their network.

Please follow the steps below for your PC's network environment installation. First of all, please check your PC's network components. The TCP/IP protocol stack and Ethernet network adapter must be installed. If not, please refer to your Windows-related or other operating system manuals.



Any TCP/IP capable workstation can be used to communicate with or through the router. To configure other types of workstations, please consult the manufacturer's documentation.

Connecting your router

1. Connect this router to a **LAN** (Local Area Network) and the ADSL/telephone (**ADSL**) network.
2. Power on the device.
3. Make sure the **PWR** and **SYS** LEDs are lit steadily and that the **LAN** LED is lit.
4. Connect an RJ11 cable to VoIP port when connecting to an analog phone set.
5. Connect RJ-11 cable to LINE Port when connecting to the telephone wall jack (**7402VGP only**).

7402VL/VGL

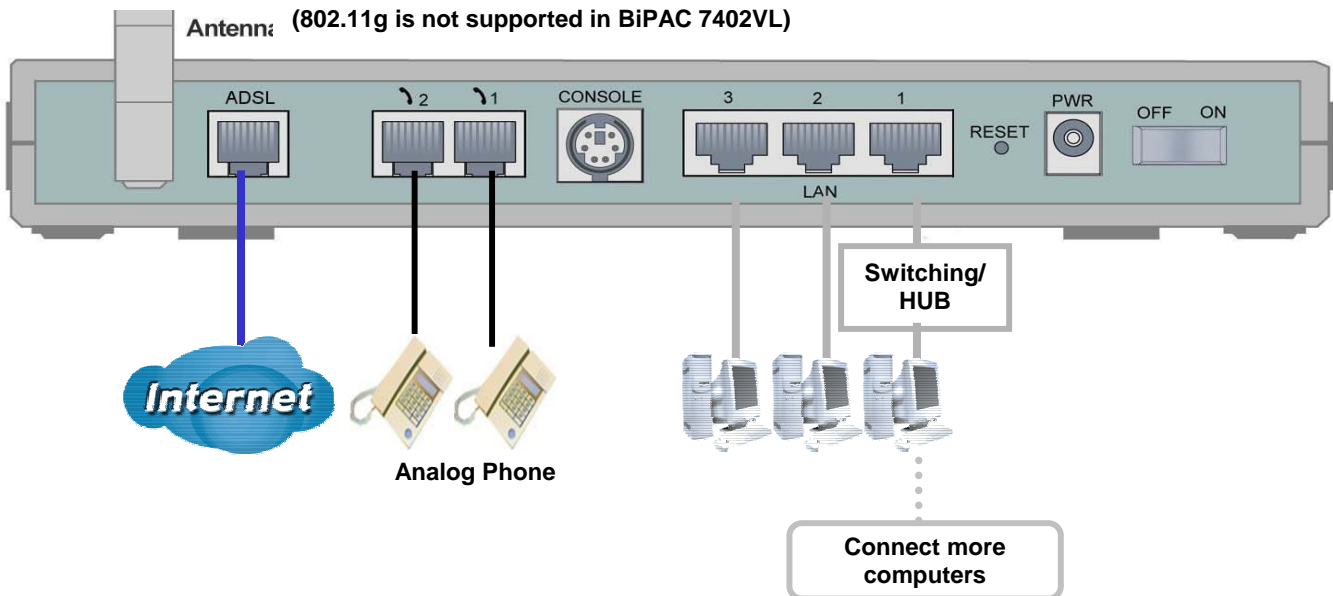

7402VGP

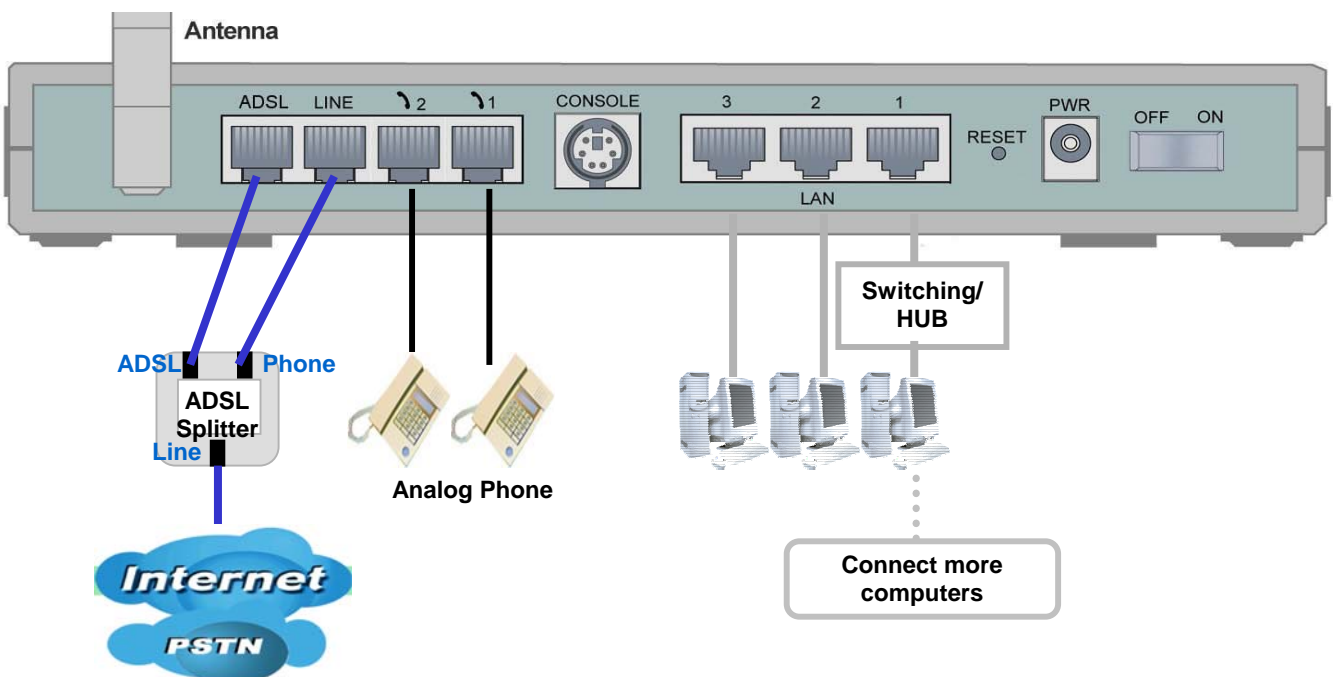

Configuring PCs in Windows in Window XP

1. Go to **Start / Control Panel** (in Classic View). In the Control Panel, double-click **Network Connections**.
2. Double-click **Local Area Connection**. (See Figure 3.1)

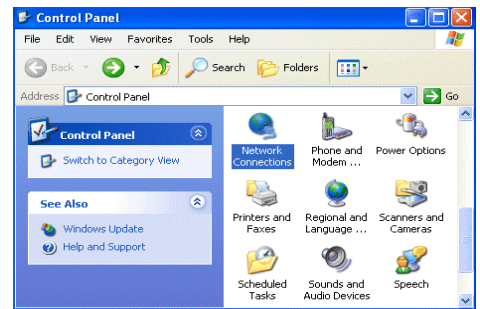

Figure 3.1: LAN Area Connection

3. In the **LAN Area Connection Status** window, click **Properties**. (See Figure 3.2)

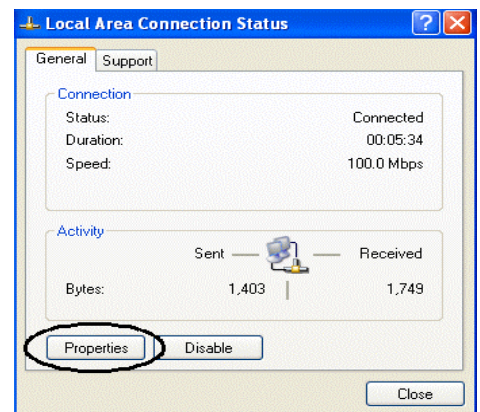

Figure 3.2: LAN Connection Status

4. Select **Internet Protocol (TCP/IP)** and click **Properties**. (See Figure 3.3)

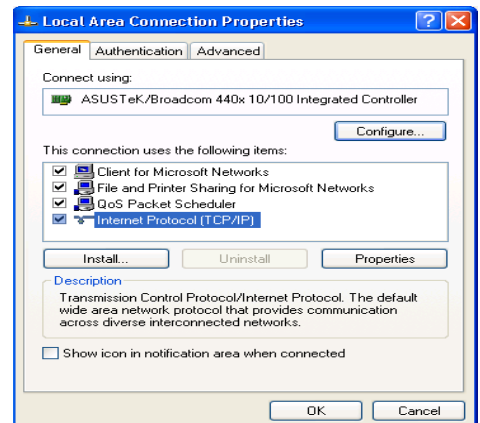

Figure 3.3: TCP / IP

5. Select the **Obtain an IP address automatically** and **Obtain DNS server address automatically** radio buttons. (See Figure 3.4)
6. Click **OK** to finish the configuration.

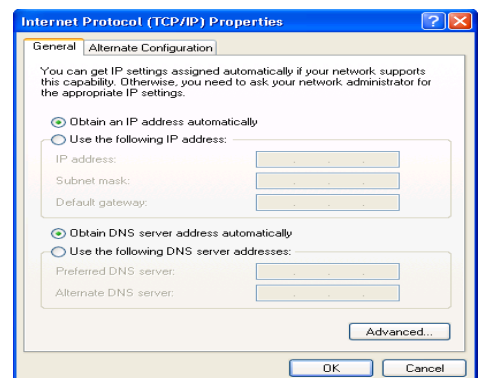

Figure 3.4: IP Address & DNS Configuration

Configuring PCs in Windows 2000

1. Go to **Start / Settings / Control Panel**. In the Control Panel, double-click **Network and Dial-up Connections**.
2. Double-click **Local Area ("LAN") Connection**. (See Figure 3.5)



Figure 3.5: LAN Area Connection

3. In the **LAN Area Connection Status** window, click **Properties**. (See Figure 3.6)

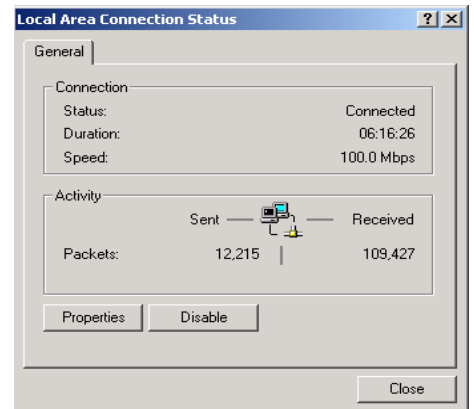

Figure 3.6: LAN Connection Status

4. Select **Internet Protocol (TCP/IP)** and click **Properties**. (See Figure 3.7)

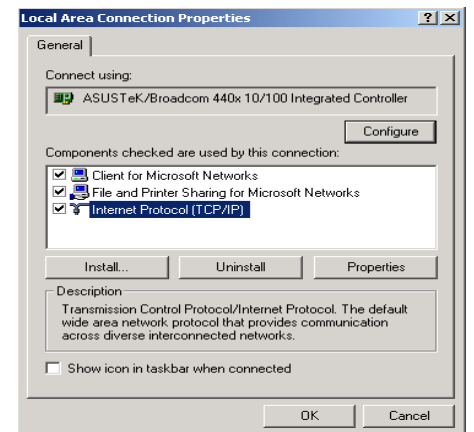

Figure 3.7: TCP / IP

5. Select the **Obtain an IP address automatically** and **Obtain DNS server address automatically** radio buttons. (See Figure 3.8)
6. Click **OK** to finish the configuration.

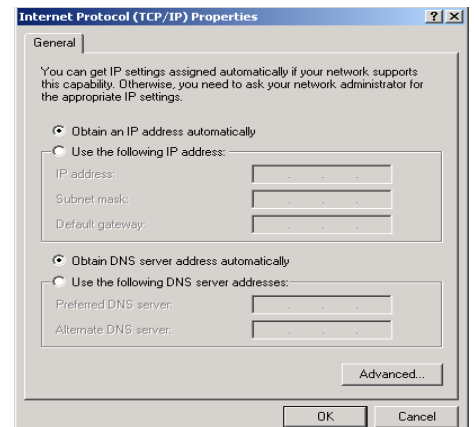

Figure 3.8: IP Address & DNS Configuration

Configuring PC in Windows 95/98/ME

1. Go to **Start / Settings / Control Panel**. In the Control Panel, double-click **Network** and choose the **Configuration** tab.
2. Select **TCP / IP -> NE2000 Compatible**, or the name of any Network Interface Card (NIC) in your PC. (See Figure 3.9)
3. Click **Properties**.

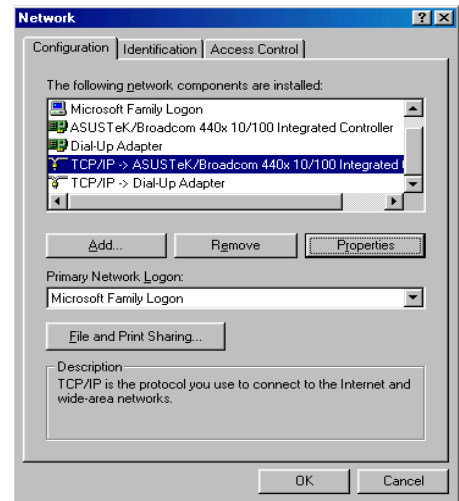

Figure 3.9: TCP / IP

4. Select the **IP Address** tab. In this page, click the Obtain an IP address automatically radio button. (See Figure 3.10)

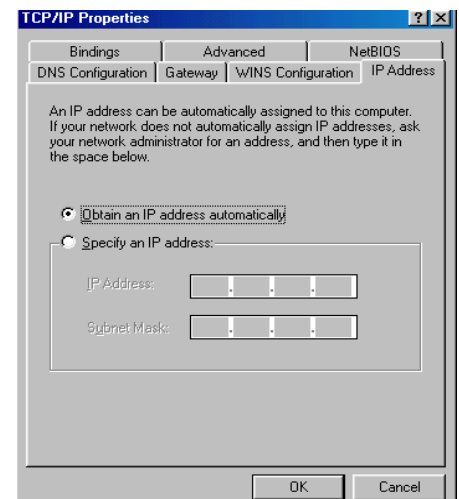

Figure 3.10: IP Address

5. Then select the **DNS Configuration** tab. (See Figure 3.11)
6. Select the **Disable DNS** radio button and click **OK** to finish the configuration.

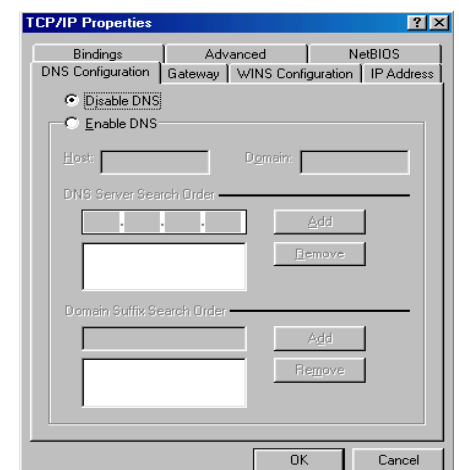

Figure 3.11: DNS Configuration

Configuring PC in Windows NT4.0

1. Go to **Start / Settings / Control Panel**. In the Control Panel, double-click **Network** and choose the **Protocols** tab.
2. Select **TCP/IP Protocol** and click **Properties**. (See Figure 3.12)

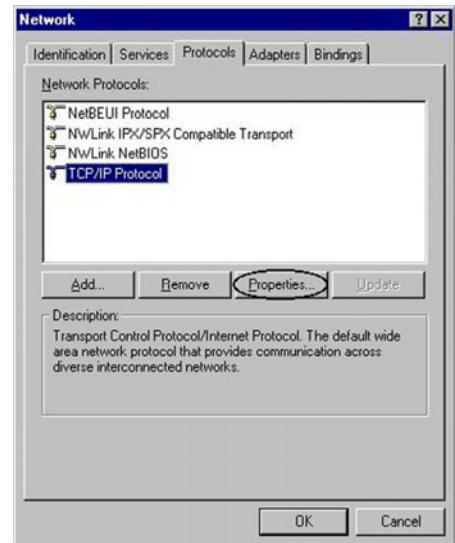

Figure 3.12: TCP / IP

3. Select the **Obtain an IP address from a DHCP server** radio button and click **OK**. (See Figure 3.13)

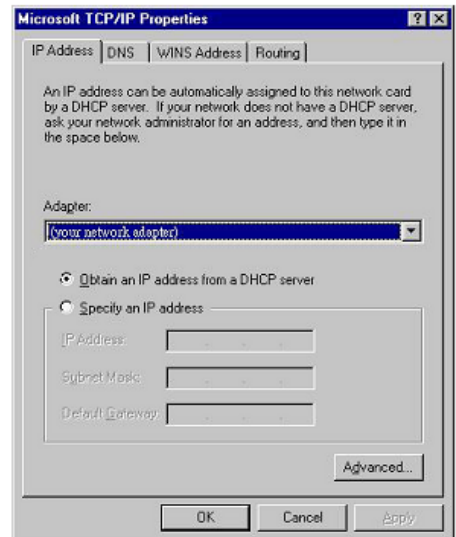

Figure 3.13: IP Address

Factory Default Settings

Before configuring your, you need to know the following default settings.

Web Interface (Username and Password)

- ▶ Username: admin
- ▶ Password: admin

The default username and password are “**admin**” and “**admin**” respectively.



If you ever forget the password to log in, you may press the RESET button up to 6 seconds to restore the factory default settings.

Attention

LAN Device IP Settings

- ▶ IP Address: 192.168.1.254
- ▶ Subnet Mask: 255.255.255.0

ISP setting in WAN site

- ▶ PPPoE

DHCP server

- ▶ DHCP server is enabled.
- ▶ Start IP Address: 192.168.1.100
- ▶ IP pool counts: 100

LAN and WAN Port Addresses

The parameters of LAN and WAN ports are pre-set in the factory. The default values are shown below.

LAN Port		WAN Port
IP address	192.168.1.254	The PPPoE function is <i>enabled</i> to automatically get the WAN port configuration from the ISP, but you have to set the username and password first.
Subnet Mask	255.255.255.0	
DHCP server function	Enabled	
IP addresses for distribution to PCs	100 IP addresses continuing from 192.168.1.100 through 192.168.1.199	

Information from your ISP

Before configuring this device, you have to check with your ISP (Internet Service Provider) what kind of service is provided such as PPPoE, PPPoA, RFC1483, or IPoA.

Gather the information as illustrated in the following table and keep it for reference.

PPPoE	VPI/VCI, VC-based/LLC-based multiplexing, Username, Password, Service Name, and Domain Name System (DNS) IP address (it can be automatically assigned by your ISP when you connect or be set manually).
PPPoA	VPI/VCI, VC-based/LLC-based multiplexing, Username, Password, and Domain Name System (DNS) IP address (it can be automatically assigned by your ISP when you connect or be set manually).
RFC1483 Bridged	VPI/VCI, VC-based/LLC-based multiplexing to use Bridged Mode.
RFC1483 Routed	VPI/VCI, VC-based/LLC-based multiplexing, IP address, Subnet mask, Gateway address, and Domain Name System (DNS) IP address (it is fixed IP address).
IPoA	VPI/VCI, VC-based/LLC-based multiplexing, IP address, Subnet mask, Gateway address, and Domain Name System (DNS) IP address (it is fixed IP address).

Configuring with your Web Browser

Open your web browser, enter the IP address of your router, which by default is **192.168.1.254**, and click **Go**, a user name and password window prompt will appear. **The default username and password are “admin” and “admin”.** (See Figure 3.14)



Figure 3.14: User name & Password Prompt Window

Congratulation! You are now successfully logon to the VoIP ADSL Router!

Chapter 4: Configuration

At the configuration homepage, the left navigation pane where bookmarks are provided links you directly to the desired setup page, including:

- **Status** (ARP Table, Wireless Association Table, Routing Table, DHCP Table, Email Status, VoIP Status, Event Log, Error Log, NAT Sessions and UPnP Portmap)
- **Quick Start**
- **Configuration**
(LAN, WAN, System, Firewall, VoIP, QoS, Virtual Server, Time Schedule and Advanced)
- **Save Config to FLASH**
- **Language** (provides user interface in English and Deutsch languages)

Please see the relevant sections of this manual for detailed instructions on how to configure the VoIP ADSL Router.

Status

ARP Table

This section displays the router's ARP (Address Resolution Protocol) Table, which shows the mapping of Internet (IP) addresses to Ethernet (MAC) addresses. This is useful as a quick way of determining the MAC address of the network interface of your PCs to use with the router's **Firewall – MAC Address Filter** function. See the Firewall section of this manual for more information on this feature.

ARP Table			
IP <> MAC List			
IP Address	MAC Address	Interface	Static
192.168.1.187	00:0c:6e:bd:11:6d	iplan	no

IP Address: A list of IP addresses of devices on your LAN (Local Area Network).

MAC Address: The MAC (Media Access Control) addresses for each device on your LAN.

Interface: The interface name (on the router) that this IP Address connects to.

Static: Static status of the ARP table entry:

- ⊙ “no” for dynamically-generated ARP table entries
- ⊙ “yes” for static ARP table entries added by the user

Wireless Association Table (7402VGL/VGP only)

Wireless Association Table	
Wireless client's MAC address and the corresponding IP address	
IP Address	MAC
192.168.1.100	00:04:23:73:9a:86

IP Address: It is IP address of wireless client that joins this network.

MAC: The MAC address of wireless client.

Routing Table

Routing Table				
Routing Table				
Valid	Destination	Netmask	Gateway/Interface	Cost

RIP Routing Table			
Destination	Netmask	Gateway	Cost

Routing Table

Valid: It indicates a successful routing status.

Destination: The IP address of the destination network.

Netmask: The destination netmask address.

Gateway/Interface: The IP address of the gateway or existing interface that this route will use.

Cost: The number of hops counted as the cost of the route.

RIP Routing Table

Destination: The IP address of the destination network.

Netmask: The destination netmask address.

Gateway: The IP address of the gateway that this route will use.

Cost: The number of hops counted as the cost of the route.

DHCP Table

DHCP Table

Type

Leased ▶

Expired ▶

Permanent ▶

Leased: The DHCP assigned IP addresses information.

IP Address: A list of IP addresses of devices on your LAN (Local Area Network).

Expired: The expired IP addresses information.

Permanent: The fixed host mapping information

Leased Table

Leased Table

IP Address	MAC Address	Client Host Name	Expiry
------------	-------------	------------------	--------

IP Address: The IP address that assigned to client.

MAC Address: The MAC address of client.

Client Host Name: The Host Name (Computer Name) of client.

Expiry: The current lease time of client.

Expired Table

Expired Table

IP Address	MAC Address	Client Host Name	Expiry
------------	-------------	------------------	--------

Please refer the **Leased Table**.

Permanent Table

Permanent Table

Name	IP Address	MAC Address	Maximum Lease Time
------	------------	-------------	--------------------

Name: The name you assigned to the Permanent configuration.

IP Address: The fixed IP address for the specify client.

MAC Address: The MAC Address that you want to assign the fixed IP address

Maximum Lease Time: The maximum lease time interval you allow to clients

Email Status

Details and status for the Email Account you have configured the router to check. Please see the **Advanced** section of this manual for details on this function.

Email Status	
Email Account	
Account Name	username
POP3 Mail Server	pop3.mail.com
Email Status	No mail
<input type="button" value="Reset Status"/> <input type="button" value="Check Now"/>	

VoIP Status

Details and status for the VoIP Account you have configured the router to check. Please see the **Phone Configuration** section of this manual for details on this function.

Phone Configuration			
Phone Port			
Port	Phone number	Display Name	Registered
1	1		unknown
2	2		unknown

Event Log

This page displays the router's Event Log entries. Major events are logged to this window, such as when the router's ADSL connection is disconnected, as well as Firewall events when you have enabled Intrusion or Blocking Logging in the **Configuration – Firewall** section of the interface. Please see the **Firewall** section of this manual for more details on how to enable Firewall logging.

Event Log
<pre> ----- system log buffer head ----- ----- system log buffer tail ----- </pre>
<input type="button" value="Refresh"/> <input type="button" value="Clear"/>

Error Log

Any errors encountered by the router (e.g. invalid names given to entries) are logged to this window.

Error Log

Error Log (*times are in seconds since last reboot*)

When	Process	Error Log
------	---------	-----------

NAT Sessions

This section lists all current NAT sessions between interface of types external (WAN) and internal (LAN).

NAT Sessions

Active NAT sessions between interface of types external and internal:

Prot	Local IP: Port	local/public	Remote IP: Port	Idle (sec.)
TCP	192.168. 1.201:	1110/ 1110	64. 94.110. 12:	80 29
TCP	192.168. 1. 99:	1982/ 1982	210.184.108.126:	80 729
TCP	192.168. 1. 99:	1979/ 1979	207. 68.178.239:	80 542
TCP	192.168. 1.202:	2011/ 2011	207. 46.107. 27:	1863 21
TCP	192.168. 1.100:	1166/ 1166	207. 46.106. 90:	1863 18
TCP	192.168. 1. 99:	1969/ 1969	207. 46.107. 22:	1863 673
ICMP	192.168. 1.201:	512/ 512	168. 95. 4.211:	512 0

TCP : 6 sessions
 UDP : 0 sessions
 Others : 1 sessions
 Total : 7 sessions

Refresh

UPnP Portmap

The section lists all port-mapping established using UPnP (Universal Plug and Play). Please see the **Advanced** section of this manual for more details on UPnP and the router's UPnP configuration options.

UPnP Portmap

UPnP Portmap Table

Name	Protocol	External Port	Redirect Port	IP Address
emwebigd1024	udp	35324 ~ 35324	15852 ~ 15852	192.168.1.205
emwebigd1025	tcp	48888 ~ 48888	14811 ~ 14811	192.168.1.205
emwebigd1063	udp	9210 ~ 9210	15169 ~ 15169	192.168.1.202
emwebigd1064	tcp	50937 ~ 50937	14500 ~ 14500	192.168.1.202

Quick Start

Quick Start	
Connection	
Encapsulation	PPPoE <input type="button" value="Auto Scan"/>
VPI	0
VCI	33
NAT	<input checked="" type="radio"/> Enable <input type="radio"/> Disable
Optional Settings	
IP Address	0.0.0.0 (0.0.0.0 means 'Obtain an IP address automatically')
SubNetmask	0.0.0.0
Default Gateway	0.0.0.0
DNS	
Obtain DNS automatically	<input type="checkbox"/> Enable
Primary DNS	<input type="text"/>
Secondary DNS	<input type="text"/>
PPP	
Username	<input type="text"/>
Password	<input type="text"/>
<input type="button" value="Apply"/> <input type="button" value="Cancel"/>	

For detailed instructions on configuring your WAN settings, please see the **WAN** section of this manual.

Usually, the only details you will need for the Quick Start wizard to get you online are your login (often in the form of *username@ispname*), your password and the encapsulation type. In addition, you have the option to provide specific DNS as your desire, or check the **Enable** box to get the DNS automatically from your ISP.

Your ISP will be able to supply all the details you need, alternatively, if you have deleted the current WAN Connection in the **WAN – ISP** section of the interface, you can use the router's PVC Scan feature to attempt to determine the Encapsulation types offered by your ISP.

Auto Scan

Before you scan the PVCs, please DELETE all the WAN interfaces.

IP Address	<input type="text"/>	if provided by ISP
Gateway	<input type="text"/>	if provided by ISP
<input type="button" value="Start"/>		

Click **Start** to begin scanning for encapsulation types offered by your ISP. If the scan is successful you will then be presented with a list of supported options:

The screenshot displays the configuration interface of a VoIP/(802.11g) ADSL2+ Router. On the left side, there is a vertical navigation menu with the following options: Status, Quick Start, Configuration, Save Config to FLASH, and Language. The main content area shows a list of found PPPoE PVCs, with the first entry highlighted: "1 found PPPoE PVC on 0/33". Below this list is an "Apply" button. Underneath the "Apply" button is a section titled "Auto Scan" which contains a large, empty text input field with a scroll bar on the right side. At the bottom of this section is a "Cancel" button.

Select the desired option from the list and click **Apply** to return to the Quick Start interface to continue configuring your ISP connection. Please note that the contents of this list will vary, depending on what is supported by your ISP.

Configuration

When you click this item, you get following sub-items to configure the ADSL router.

LAN, WAN, System, Firewall, VoIP, QoS, Virtual Server, Time Schedule and Advanced

These functions are described below in the following sections.

LAN (Local Area Network)

There are seven items within the LAN section: [Ethernet](#), [Ethernet Client Filter](#), [Wireless](#), [Wireless Security](#), [Wireless Client Filter](#), [Port Setting](#) and [DHCP Server](#).

Ethernet

Ethernet				
Primary IP Address				
IP Address	192	168	1	254
SubNetmask	255	255	255	0
RIP	<input type="checkbox"/> RIP v1 <input type="checkbox"/> RIP v2 <input type="checkbox"/> RIP v2 Multicast			
Secondary IP Address				
The Secondary IP Address should be on the same subnet as the Primary IP Address and uses the same Subnet Mask.				
IP Address	0	0	0	0
<input type="button" value="Apply"/>				

The router supports two Ethernet IP addresses in the LAN, and two different LAN subnets through which you can access the Internet at the same time. Users usually only have one subnet in their LAN, so there is no need to configure a Secondary IP address. The default IP address for the router is 192.168.1.254.

RIP: RIP v1, RIP v2, and RIP v2 Multicast. Check to enable RIP function.

Ethernet Client Filter

The Ethernet Client Filter supports up to 16 Ethernet network machines that helps you to manage your network control to accept traffic from specific authorized machines or can restrict unwanted machine(s) to access your LAN.

There are no pre-define Ethernet MAC address filter rules; you can add the filter rules to meet your requirements.

Ethernet Client Filter

Filtering Rules

Ethernet Client Filter	<input checked="" type="radio"/> Disable	<input type="radio"/> Allowed	<input type="radio"/> Blocked
MAC Address List	<input type="text"/>	<input type="text"/>	<input type="text"/>
Candidates	<input type="text"/>	<input type="text"/>	<input type="text"/>
(MAC Address Format is 'xx:xx:xx:xx:xx:xx')	<input type="text"/>	<input type="text"/>	<input type="text"/>
	<input type="text"/>	<input type="text"/>	<input type="text"/>
	<input type="text"/>	<input type="text"/>	<input type="text"/>
	<input type="text"/>	<input type="text"/>	<input type="text"/>
	<input type="text"/>	<input type="text"/>	<input type="text"/>

Ethernet Client Filter: Default setting is set to **Disable**.

Allowed: check to authorize specific device accessing your LAN by insert the MAC Address in the space provided or click [Candidates](#). Make sure your PC's MAC is listed.

Blocked: check to prevent unwanted device accessing your LAN by insert the MAC Address in the space provided or click [Candidates](#). Make sure your PC's MAC is not listed.

The maximum client is 16. The MAC addresses are 6 bytes long; they are presented only in hexadecimal characters. The number 0 - 9 and letters a - f are acceptable.

(Note: Follow the MAC Address Format xx:xx:xx:xx:xx:xx. Semicolon (:) must be included)

Candidates: automatically detects devices connected to the router through the Ethernet. .

[Candidates](#) → Active PC in LAN

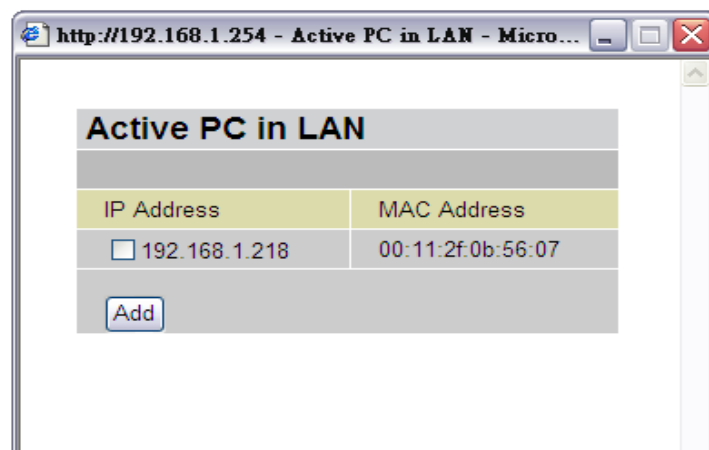

Active PC in LAN displays a list of individual Ethernet device's IP Address & MAC Address which connecting to the router.

You can easily by checking the box next to the IP address to be blocked or allowed. Then, **Add** to insert to the Ethernet Client Filter table. The maximum Ethernet client is 16.

Wireless (7402VGL/VGP only)

Wireless	
Parameters	
WLAN Service	<input checked="" type="radio"/> Enable <input type="radio"/> Disable
Mode	802.11b + g
ESSID	wlan-ap
ESSID Broadcast	<input checked="" type="radio"/> Enable <input type="radio"/> Disable
Regulation Domain	N.America
Channel ID	Channel 1 (2.412 GHz)
Connected	true
AP MAC address	00:04:ed:1e:14:b1
AP Firmware Version	1.38.1.7.06.2004
Wireless Distribution System (WDS)	
WDS Service	<input type="radio"/> Enable <input checked="" type="radio"/> Disable
Peer WDS MAC address	00:00:00:00:00:00
<input type="button" value="Apply"/> <input type="button" value="Cancel"/>	

Parameters

WLAN Service: Default setting is set to **Enable**. If you do not have any wireless, both 802.11g and 802.11b, device in your network, select **Disable**.

Mode: The default setting is **802.11b+g** (Mixed mode). If you do not know or have both 11g and 11b devices in your network, then keep the default in **mixed mode**. From the drop-down manual, you can select **802.11g** if you have only 11g card. If you have only 11b card, then select **802.11b**.

ESSID: The ESSID is the unique name of a wireless access point (AP) to be distinguished from another. For security propose, change the default **wlan-ap** to a unique ID name to the AP which is already built-in to the router's wireless interface. It is case sensitive and must not excess 32 characters. Make sure your wireless clients have exactly the ESSID as the device, in order to get connected to your network. **(Note: It is case sensitive and must not excess 32 characters.)**

ESSID Broadcast: It is function in which transmits its ESSID to the air so that when wireless client searches for a network, router can then be discovered and recognized. Default setting is **Enable**.

Disable: If you do not want broadcast your ESSID. Any client uses "any" wireless setting cannot discover the Access Point (AP) of your router.

Enable: Any client that using the "any" setting can discover the Access Point (AP) in

Regulation Domain: There are seven Regulation Domains for you to choose from, including **North America (N.America)**, **Europe**, **France**, etc. The Channel ID will be different based on this setting.

Channel ID: Select the ID channel that you would like to use.

Connected: Representing in **true** or **false**. That it is the connection status between the system and the build-in wireless card.

AP MAC Address: It is a unique hardware address of the Access Point.

AP Firmware Version: The Access Point firmware version.

Wireless Distribution System (WDS)

It is a wireless access point mode that enables wireless link and communication with other access point. It is easy to be installed simply define peer's MAC address of the connected AP. WDS takes advantages of cost saving and flexibility which no extra wireless client device is required to bridge between two access points and extending an existing wired or wireless infrastructure network to create a larger network.

In addition, WDS enhances its link connection security in WEP mode, WEP key encryption must be the same for both access points.

WDS Service: The default setting is **Disable**. Check **Enable** radio button to activate this function.

Peer WDS MAC Address: It is the associated AP's MAC Address. It is important that your peer's AP must include your MAC address in order to acknowledge and communicate with each other.

(Note: For MAC Address, Semicolon (:) must be included)

Wireless Security (7402VGL/VGP only)

You can disable or enable with WPA or WEP for protecting wireless network. The default mode of wireless security is **disabled**.

Wireless Security	
Parameters	
Security Mode	Disable <input type="button" value="v"/>
<input type="button" value="Apply"/> <input type="button" value="Cancel"/>	

WPA Pre-Shared Key

Wireless Security	
Parameters	
Security Mode	WPA Pre-Shared Key <input type="button" value="v"/>
WPA Algorithms	TKIP
WPA Shared Key	<input type="text"/>
Group Key Renewal	600 <input type="text"/> seconds
Idle Timeout	3600 <input type="text"/> seconds (120~65535)
<input type="button" value="Apply"/> <input type="button" value="Cancel"/>	

WPA Algorithms: TKIP (Temporal Key Integrity Protocol) utilizes a stronger encryption method and incorporates Message Integrity Code (MIC) to provide protection against hackers.

WPA Shared Key: The key for network authentication. The input format is in character style and key size should be in the range between 8 and 63 characters.

Group Key Renewal: The period of renewal time for changing the security key automatically between wireless client and Access Point (AP). Default value is **600** seconds.

Idle Timeout: The default idle timeout is **3600** seconds. A Timeout value base on the case of no data traffic is send or received. If Router detects no traffic in the wireless, it will start timing the clock and drop the session as it reaches to the defined timeout value. New session will be re-established after the old session.

WEP

Wireless Security	
Parameters	
Security Mode	WEP
WEP Encryption	<input type="radio"/> WEP64 <input checked="" type="radio"/> WEP128 Hex
Passphrase	<input type="text"/> <input type="button" value="Generate"/>
Default Used WEP Key	0 (0~3)
Key 0	00-00-00-00-00-00-00-00-00-00-00-01
Key 1	00-00-00-00-00-00-00-00-00-00-00-00
Key 2	00-00-00-00-00-00-00-00-00-00-00-00
Key 3	00-00-00-00-00-00-00-00-00-00-00-00
* : WDS uses Key0 for WEP encryption.	
<input type="button" value="Apply"/> <input type="button" value="Cancel"/>	

WEP Encryption: To prevent unauthorized wireless stations from accessing data transmitted over the network, the router offers highly secure data encryption, known as WEP. If you require high security for transmissions, there are two alternatives to select from: **WEP 64** and **WEP 128**. WEP 128 will offer increased security over WEP 64.

Passphrase: This is used to generate WEP keys automatically based upon the input string and a pre-defined algorithm in WEP64 or WEP128. You can input the same string in both the AP and Client card settings to generate the same WEP keys. Please note that you do not have to enter **Key (0-3)** as below when the **Passphrase** is enabled.

Default Used WEP Key: Select the encryption key ID; please refer to **Key (0-3)** below.

Key (0-3): Enter the key to encrypt wireless data. To allow encrypted data transmission, the WEP Encryption Key values on all wireless stations must be the same as the router. There are four keys for your selection. The input format is in HEX style, 5 and 13 HEX codes are required for WEP64 and WEP128 respectively, the separator is "-". For example, using WEP64, 11-22-33-44-55 is a valid key, whilst 1122334455 is invalid.

Wireless Client (MAC Address) Filter (7402VGL/VGP only)

The MAC Address supports up to 16 wireless network machines and helps you to manage your network control to accept traffic from specific authorized machines or to restrict unwanted machine(s) to access your LAN.

There are no pre-define MAC Address filter rules; you can add the filter rules to meet your requirements.

Wireless Client (MAC Address) Filter

Filtering Rules

Filter Action	<input checked="" type="radio"/> Disable	<input type="radio"/> Allowed	<input type="radio"/> Blocked
MAC Address List Candidates ▶ (MAC Address Format is 'xx:xx:xx:xx:xx:xx')	<input type="text"/>	<input type="text"/>	<input type="text"/>
	<input type="text"/>	<input type="text"/>	<input type="text"/>
	<input type="text"/>	<input type="text"/>	<input type="text"/>
	<input type="text"/>	<input type="text"/>	<input type="text"/>
	<input type="text"/>	<input type="text"/>	<input type="text"/>
	<input type="text"/>	<input type="text"/>	<input type="text"/>
	<input type="text"/>	<input type="text"/>	<input type="text"/>
	<input type="text"/>	<input type="text"/>	<input type="text"/>

Ethernet Client Filter: Default setting is set to **Disable**.

Allowed: check to authorize specific device accessing your LAN by insert the MAC Address in the space provided or click [Candidates](#) ▶. Make sure your PC's MAC is listed.

Blocked: check to prevent unwanted device accessing the LAN by insert the MAC Address in the space provided or click [Candidates](#) ▶. Make sure your PC's MAC is not listed.

The maximum client is 16. The MAC addresses are 6 bytes long; they are presented only in hexadecimal characters. The number **0 - 9** and letters **a - f** are acceptable.

The maximum client is 16. The MAC addresses are 6 bytes long; they are presented only in hexadecimal characters. The number **0 - 9** and letters **a - f** are acceptable.

(Note: Follow the MAC Address Format xx:xx:xx:xx:xx:xx. Semicolon (:) must be included)

Candidates: it automatically detects devices connected to the router through the Ethernet. .

[Candidates](#) ▶ → **Associated Wireless Clients**

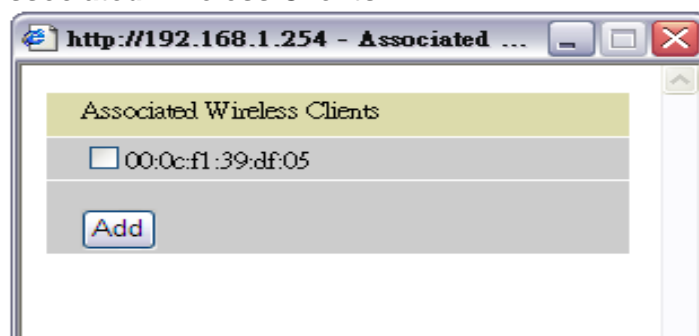

Associate Wireless Client displays a list of individual wireless device's MAC Address that currently connects to the router.

You can easily by checking the box next to the MAC address to be blocked or allowed. Then, **Add** to insert to the Wireless Client (MAC Address) Filter table. The maximum Ethernet client is 16.

DHCP Server

You can disable or enable the DHCP (Dynamic Host Configuration Protocol) server or enable the router's DHCP relay functions. The DHCP protocol allows your router to dynamically assign IP addresses to PCs on your network if they are configured to obtain IP addresses automatically.

DHCP Server	
Configuration	
DHCP Server Mode	<input type="radio"/> Disable
	<input checked="" type="radio"/> DHCP Server
	<input type="radio"/> DHCP Relay Agent
<input type="button" value="Next"/>	

DHCP Server Status	
Allow Bootp	true
Allow Unknown Clients	true
Enable	true
Subnet Definitions	
Subnet Value	192.168.1.0
SubNetmask	255.255.255.0
Maximum Lease Time	86400 seconds
Default Lease Time	43200 seconds
Use local host address as DNS server	true
Use local host address as default gateway	true
Get subnet from IP interface	iplan
IP Range 192.168.1.100- 192.168.1.199	
Option <i>domain-name-servers</i> = 0.0.0.0	

To disable the router's DHCP Server, check **Disabled** and click **Next**, then click **Apply**. When the DHCP Server is disabled you will need to manually assign a fixed IP address to each PCs on your network, and set the default gateway for each PCs to the IP address of the router (by default this is 192.168.1.254).

To configure the router's DHCP Server, check **DHCP Server** and click **Next**. You can then configure parameters of the DHCP Server including the IP pool (starting IP address and ending IP address to be allocated to PCs on your network), lease time for each assigned IP address (the period of time the IP address assigned will be valid), DNS IP address and the gateway IP address. These details are sent to the DHCP client (i.e. your PC) when it requests an IP address from the DHCP server. Click **Apply** to enable this function. If you check "**Use Router as a DNS Server**", the ADSL Router will perform the domain name lookup, find the IP address from the outside network automatically and forward it back to the requesting PC in the LAN (your Local Area Network).

If you check **DHCP Relay Agent** and click **Next**, then you will have to enter the IP address of the DHCP server which will assign an IP address back to the DHCP client in the LAN. Use this function only if advised to do so by your network administrator or ISP.

Click **Apply** to enable this function.

WAN (Wide Area Network)

WAN refers to your Wide Area Network connection, i.e. your router's connection to your ISP and the Internet. There are two items within the **WAN** section: **ISP**, **DNS** and **ADSL**.

ISP

WAN Connection						
WAN Services Table						
Name	Description	Creator	VPI	VCI		
wanlink	PPPoE WAN Link	Factory Defaults	0	32	Edit ▶	Change ▶

The factory default is PPPoE. If your ISP uses this access protocol, click **Edit** to input other parameters as below. If your ISP does not use PPPoE, you can change the default WAN connection entry by clicking **Change**.

A simpler alternative is to select **Quick Start** from the main menu on the left. Please see the Quick Start section of the manual for more information.

RFC 1483 Routed Connections

WAN Connection	
RFC 1483 Routed	
Description	<input type="text" value="RFC 1483 routed mode"/>
VPI	<input type="text" value="0"/>
VCI	<input type="text" value="32"/>
ATM Class	<input type="text" value="UBR"/> <input type="button" value="v"/>
NAT	<input checked="" type="radio"/> Enable <input type="radio"/> Disable
Encapsulation Method	<input type="text" value="LLC Bridged"/> <input type="button" value="v"/>
IP Assignment	<input checked="" type="radio"/> Obtain an IP address automatically via DHCP client
	<input type="radio"/> Use the following IP address
	IP Address <input type="text"/>
	Netmask <input type="text"/>
	Gateway <input type="text"/>
RIP	<input type="checkbox"/> RIP v1 <input type="checkbox"/> RIP v2 <input type="checkbox"/> RIP v2 Multicast
MTU	<input type="text" value="1500"/>
<input type="button" value="Apply"/>	

Description: Your description of this connection.

VPI and VCI: Enter the information provided by your ISP.

ATM Class: The Quality of Service for ATM layer.

NAT: The NAT (Network Address Translation) feature allows multiple users to access the Internet through a single IP account, sharing the single IP address. If users on your LAN have public IP addresses and can access the Internet directly, the NAT function can be disabled.

Encapsulation method: Selects the encapsulation format, the default is LLC Bridged. Select the one provided by your ISP.

DHCP client: Enable or disable the DHCP client, specify if the Router can get an IP address from the Internet Service Provider (ISP) automatically or not. Please click **Obtain an IP address automatically via DHCP client** to enable the DHCP client function or click Specify an IP address to disable the DHCP client function, and specify the IP address manually. Your ISP specifies the setting of this item.

RIP: RIP v1, RIP v2, and RIP v2 Multicast. Check to enable RIP function.

MTU: Maximum Transmission Unit. The size of the largest datagram (excluding media-specific headers) that IP will attempt to send through the interface.

RFC 1483 Bridged Connections

WAN Connection	
RFC 1483 Bridged	
Description	RFC 1483 bridged mode
VPI	0
VCI	32
ATM Class	UBR <input type="button" value="v"/>
Encapsulation Method	LLC Bridged <input type="button" value="v"/>
Ether Filter Type	All <input type="button" value="v"/>
Spanning Bridge Interface	<input checked="" type="radio"/> Enable <input type="radio"/> Disable
<input type="button" value="Apply"/>	

VPI and VCI: Enter the information provided by your ISP.

ATM Class: The Quality of Service for ATM layer.

Encapsulation method: Select the encapsulation format, this is provided by your ISP.

Ether Filter Type: Specify the type of ethernet filtering performed by the named bridge interface.

All	Allows all types of ethernet packets through the port.
Ip	Allows only IP/ARP types of ethernet packets through the port.
Pppoe	Allows only PPPoE types of ethernet packets through the port.

Spanning Bridge Interface: Enable/Disable spanning tree function of modem.

PPPoA Routed Connections

WAN Connection	
PPPoA Routed	
Description	PPPoA Routed
VPI	0
VCI	32
ATM Class	UBR <input type="button" value="v"/>
NAT	<input checked="" type="radio"/> Enable <input type="radio"/> Disable
Username	<input type="text"/>
Password	<input type="text"/>
IP Address	0.0.0.0 (0.0.0.0' means 'Obtain an IP address automatically')
Authentication Protocol	Chap(Auto) <input type="button" value="v"/>
Connection	Always On <input type="button" value="v"/>
Idle Timeout	0 minutes Details <input type="button" value="▶"/>
RIP	<input type="checkbox"/> RIP v1 <input type="checkbox"/> RIP v2 <input type="checkbox"/> RIP v2 Multicast
MTU	1500
<input type="button" value="Apply"/> Advanced Options <input type="button" value="▶"/>	

Description: User-definable name for the connection.

VPI/VCI: Enter the information provided by your ISP.

ATM Class: The Quality of Service for ATM layer.

NAT: The NAT (Network Address Translation) feature allows multiple users to access the Internet through a single IP account, sharing a single IP address. If users on your LAN have public IP addresses and can access the Internet directly, the NAT function can be disabled.

Username: Enter the username provided by your ISP. You can input up to **128** alphanumeric characters (case sensitive). This will usually be in the format of “username@ispname” instead of simply “username”.

Password: Enter the password provided by your ISP. You can input up to **128** alphanumeric characters (case sensitive).

IP Address: Specify an IP address allowed to logon and access the router’s web server.. Note: IP 0.0.0.0 indicates all users who are connected to this router are allowed to logon the device and modify data.

Authentication Protocol Type: Default is **Chap (Auto)**. Your ISP will advise you whether to use **Chap** or **Pap**.

Connection:

☉ **Always on:** If you want the router to establish a PPPoA session when starting up and to automatically re-establish the PPPoA session when disconnected by the ISP.

☉ **Connect to Demand:** If you want to establish a PPPoA session only when there is a packet requesting access to the Internet (i.e. when a program on your computer attempts to access the Internet).

Idle Timeout: Auto-disconnect the broadband firewall gateway when there is no activity on the line for a predetermined period of time.

☉ **Detail:** You can define the destination port and packet type (TCP/UDP) without checking by timer. It allows you to set which outgoing traffic will not trigger and reset the idle timer.

RIP: RIP v1, RIP v2, and RIP v2 Multicast. Check to enable RIP function.

MTU: Maximum Transmission Unit. The size of the largest datagram (excluding media-specific headers) that IP will attempt to send through the interface.

Advanced Options (PPPoA)

LLC Header: Selects encapsulation mode, true for using LLC or false for using VC-Mux.

Create Route: This setting specifies whether a route is added to the system after IPCP (Internet Protocol Control Protocol) negotiation is completed. If set to *enabled*, a route will be created which directs packets to the remote end of the PPP link.

Specific Route: Specifies whether the route created when a PPP link comes up is a specific or default route. If set to *enabled*, the route created will only apply to packets for the subnet at the remote end of the PPP link. The address of this subnet is obtained during IPCP negotiation.

Subnet Mask: sets the subnet mask used for the local IP interface connected to the PPP transport. If the value *0.0.0.0* is supplied, the netmask will be calculated from the class of the IP address obtained during IPCP negotiation.

Route Mask: Sets the subnet mask used by the route that is created when a PPP link comes up. If it is set to *0.0.0.0*, the subnet mask is determined by the IP address of the remote end of the link. The class of the IP address is obtained during IPCP (Internet Protocol Control Protocol) negotiation.

MRU: Maximum Receive Unit. This is negotiated during the LCP protocol stage.

Discover Primary / Secondary DNS: This setting enables/disables whether the primary/secondary DNS server address is requested from a remote PPP peer using IPCP. The default setting for this command is *enabled*.

Give DNSto Relay: Controls whether the PPP Internet Protocol Control Protocol (IPCP) can request the DNS server IP address for a remote PPP peer. Once IPCP has discovered the DNS server IP address, it automatically gives the address to the local DNS relay so that a connection can be established.

Give DNSto Client: Controls whether the PPP Internet Protocol Control Protocol (IPCP) can request a DNS server IP address for a remote PPP peer. Once IPCP has discovered the DNS server IP address, it automatically gives the address to the local DNS client so that a connection can be established.

Give DNS to DHCP Server: Similar to the above, but gives the DNS server address to the DHCP server.

Discover Primary NBNS / Discover Secondary NBNS: This setting enables/disables whether the primary/secondary NBNS server address is requested from a remote PPP peer using IPCP. The default setting for this command is disabled.

Discover Subnet Mask: Specifies if the subnet mask given by IPCP negotiation process is to be used.

Give Subnet Mask To DHCP Server: Enable to change your DHCP Server settings by using the given information in IPCP negotiation process.

IPoA Routed Connections

WAN Connection	
IPoA Routed	
Description	<input type="text" value="IPoA routed"/>
VPI	<input type="text" value="0"/>
VCI	<input type="text" value="32"/>
ATM Class	<input type="text" value="UBR"/> ▾
NAT	<input checked="" type="radio"/> Enable <input type="radio"/> Disable
IP Assignment	<input checked="" type="radio"/> Obtain an IP address automatically via DHCP client
	<input type="radio"/> Use the following IP address
	IP Address <input type="text"/>
	Netmask <input type="text"/>
	Gateway <input type="text"/>
RIP	<input type="checkbox"/> RIP v1 <input type="checkbox"/> RIP v2 <input type="checkbox"/> RIP v2 Multicast
MTU	<input type="text" value="1500"/>
<input type="button" value="Apply"/>	

Description: User-definable name for the connection.

VPI/VCI: Enter the information provided by your ISP.

ATM Class: The Quality of Service for ATM layer.

NAT: The NAT (Network Address Translation) feature allows multiple users to access the Internet through a single IP account, sharing a single IP address. If users on your LAN have public IP addresses and can access the Internet directly, the NAT function can be disabled.

DHCP client: Enable or disable the DHCP client, specifying if the router can obtain an IP address from the Internet Service Provider (ISP) automatically or not. Please click **Obtain an IP address automatically via DHCP client** to enable the DHCP client function or click **Specify an IP address** to disable the DHCP client function, and specify the IP address manually. Your ISP specifies the setting of this item.

RIP: RIP v1, RIP v2, and RIP v2 Multicast. Check to enable RIP function.

MTU: Maximum Transmission Unit. The size of the largest datagram (excluding media-specific headers) that IP will attempt to send through the interface.

PPPoE Connections

WAN Connection	
PPPoE Routed	
Description	PPPoE WAN Link
VPI	0
VCI	32
ATM Class	UBR
NAT	<input checked="" type="radio"/> Enable <input type="radio"/> Disable
Username	
Password	
Service Name	
IP Address	0.0.0.0 (0.0.0.0' means 'Obtain an IP address automatically')
Authentication Protocol	Chap(Auto)
Connection	Always On
Idle Timeout	0 minutes Details
RIP	<input type="checkbox"/> RIP v1 <input type="checkbox"/> RIP v2 <input type="checkbox"/> RIP v2 Multicast
MTU	1492
<input type="button" value="Apply"/> Advanced Options	

Description: A user-definable name for this connection.

VPI/VCI: Enter the information provided by your ISP.

ATM Class: The Quality of Service for ATM layer.

NAT: The NAT (Network Address Translation) feature allows multiple users to access the Internet through a single ISP account, sharing a single IP address. If users on your LAN have public IP addresses and can access the Internet directly, the NAT function can be disabled.

Username: Enter the username provided by your ISP. You can input up to **128** alphanumeric characters (case sensitive). This will usually be in the format of “username@ispname” instead of simply “username”.

Password: Enter the password provided by your ISP. You can input up to **128** alphanumeric characters (case sensitive).

Service Name: This item is for identification purposes. If it is required, your ISP will provide you the information. Maximum input is **20** alphanumeric characters.

IP Address: specify if the Router can get an IP address from the Internet Server Provider (ISP) automatically or not. Please click Obtain an IP address automatically via DHCP client to enable the DHCP client function or click Specify an IP address to disable the DHCP client function, and specify the IP address manually. The setting of this item is specified by your ISP.

Authentication Protocol: Default is **Chap(Auto)**. Your ISP will advise you whether to use **Chap** or **Pap**.

Connection:

☉ **Always on:** If you want the router to establish a PPPoE session when starting up and to automatically re-establish the PPPoE session when disconnected by the ISP.

☉ **Connect to Demand:** If you want to establish a PPPoE session only when there is a packet requesting access to the Internet (i.e. when a program on your computer attempts to access the Internet).

Idle Timeout: Auto-disconnect the broadband firewall gateway when there is no activity on the line for a predetermined period of time.

☉ **Detail:** You can define the destination port and packet type (TCP/UDP) without checking by timer. It allows you to set which outgoing traffic will not trigger and reset the idle timer.

RIP: RIP v1, RIP v2, and RIP v2 Multicast. Check to enable RIP function.

MTU: Maximum Transmission Unit. The size of the largest datagram (excluding media-specific headers) that IP will attempt to send through the interface.

Advanced Options (PPPoE)

LLC Header: Selects encapsulation mode, true for using LLC or false for using VC-Mux.

Create Route: This setting specifies whether a route is added to the system after IPCP (Internet Protocol Control Protocol) negotiation is completed. If set to *enabled*, a route will be created which directs packets to the remote end of the PPP link.

Specific Route: Specifies whether the route created when a PPP link comes up is a specific or default route. If set to *enabled*, the route created will only apply to packets for the subnet at the remote end of the PPP link. The address of this subnet is obtained during IPCP negotiation.

Subnet Mask: sets the subnet mask used for the local IP interface connected to the PPP transport. If the value *0.0.0.0* is supplied, the netmask will be calculated from the class of the IP address obtained during IPCP negotiation.

Route Mask: Sets the subnet mask used by the route that is created when a PPP link comes up. If it is set to *0.0.0.0*, the subnet mask is determined by the IP address of the remote end of the link. The class of the IP address is obtained during IPCP (Internet Protocol Control Protocol) negotiation.

MRU: Maximum Receive Unit. This is negotiated during the LCP protocol stage.

Discover Primary / Secondary DNS: This setting enables/disables whether the primary/secondary DNS server address is requested from a remote PPP peer using IPCP. The default setting for this command is *enabled*.

Give DNS to Relay: Controls whether the PPP Internet Protocol Control Protocol (IPCP) can request the DNS server IP address for a remote PPP peer. Once IPCP has discovered the DNS server IP address, it automatically gives the address to the local DNS relay so that a connection can be established.

Give DNS to Client: Controls whether the PPP Internet Protocol Control Protocol (IPCP) can request a DNS server IP address for a remote PPP peer. Once IPCP has discovered the DNS

server IP address, it automatically gives the address to the local DNS client so that a connection can be established.

Give DNS to DHCP Server: Similar to the above, but gives the DNS server address to the DHCP server.

Discover Primary NBNS / Discover Secondary NBNS: This setting enables/disables whether the primary/secondary NBNS server address is requested from a remote PPP peer using IPCP. The default setting for this command is disabled.

Discover Subnet Mask: Specifies if the subnet mask given by IPCP negotiation process is to be used.

Give Subnet Mask To DHCP Server: Enable to change your DHCP Server settings by using the given information in IPCP negotiation process.

DNS

DNS	
Parameters	
Obtain DNS automatically	<input checked="" type="checkbox"/> Enable
Primary DNS	<input type="text"/>
Secondary DNS	<input type="text"/>
<input type="button" value="Apply"/> <input type="button" value="Cancel"/>	

A Domain Name System (DNS) contains a mapping table for domain name and IP addresses. On the Internet, every host has a unique and user-friendly name (domain name) such as www.helloworld.com and an IP address. An IP address is a 32-bit number in the form of xxx.xxx.xxx.xxx, for example 192.168.1.254. You can think of an IP address as a telephone number for devices on the Internet, and the DNS will allow you to find the telephone number for any particular domain name. As an IP Address is hard to remember, the DNS converts the friendly name into its equivalent IP Address.

You can obtain a Domain Name System (DNS) IP address automatically if your ISP has provided it when you logon, check the **Enable** box. Usually when you choose PPPoE or PPPoA as your WAN - ISP protocol, the ISP will provide the DNS IP address automatically. You may leave the configuration field blank.

Alternatively, your ISP may provide you with an IP address of their DNS. If this is the case, you must enter the DNS IP address manually.

If you choose one of the other three protocols – RFC1483 Routed/Bridged and IPoA check with your ISP, it may provide you with an IP address for their DNS server. You must enter the DNS IP address if you set the DNS of your PC to the LAN IP address of this router.

ADSL

ADSL	
Parameters	
Connect Mode	ADSL2 ▼
Modulation	G.Dmt.Bis ▼
Activate Line	true ▼
Coding Gain	auto ▼
Tx Attenuation	Bis_0DB ▼
DSP FirmwareVersion	D.57.2.14
Connected	true
Operational Mode	G.Dmt
Annex Type	G.Dmt.Bis
Upstream	1024000
Downstream	8000000

Connect Mode: The default setting is **Multimode**. This mode will automatically detect your ADSL line code, G.dmt, G.lite, and T1.413. But in some area, multimode cannot detect the ADSL line code well. If it is the case, please adjust the ADSL line code to G.dmt or T1.413 first. If it still fails, please try the other values such as ALCTL, ADI, etc.

Activate Line: Aborting (false) your ADSL line and making it active (true) again for taking effect with setting of **Connect Mode**.

Coding Gain: Configure the ADSL coding gain from 0 dB to 7dB, or automatic.

Tx Attenuation: Setting ADSL transmission gain, the value is between 0~12.

DSP FirmwareVersion: Current ADSL line code firmware version.

Connected: Display current ADSL line sync status.

Operational Mode: Display current ADSL mode standard (Operational Mode) your Router is using when ADSL line has sync.

Annex Type: ADSL Annex A, which works over a standard telephone line. Annex B, which works over an ISDN line.

Upstream: Display current upstream rate of your ADSL line.

Downstream: Display current downstream rate of your ADSL line.

System

There are six items within the **System** section: [Time Zone](#), [Remote Access](#), [Firmware Upgrade](#), [Backup/Restore](#), [Restart](#) and [User Management](#).

Time Zone

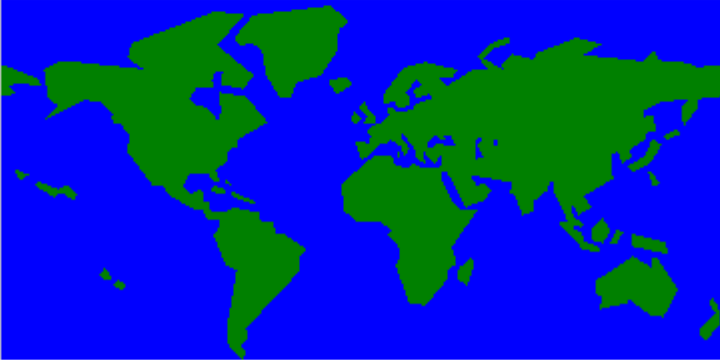
Time Zone	
Parameters	
Time Zone	<input checked="" type="radio"/> Enable <input type="radio"/> Disable
Time Zone List	<input checked="" type="radio"/> By City <input type="radio"/> By Time Difference
Local Time Zone (+-GMT Time)	(GMT)Greenwich Mean Time ▼
SNTP Server IP Address	1. <input type="text" value="carl.css.gov"/> 2. <input type="text" value="india.colorado.edu"/>
	3. <input type="text" value="time.nist.gov"/> 4. <input type="text" value="time-b.nist.gov"/>
Daylight Saving	<input checked="" type="checkbox"/> Automatic
Resync Period	<input type="text" value="1440"/> minutes
	
<input type="button" value="Apply"/> <input type="button" value="Cancel"/>	

The router does not have a real time clock on board; instead, it uses the Simple Network Time Protocol (SNTP) to get the current time from an SNTP server outside your network. Choose your local time zone, click **Enable** and click the **Apply** button. After a successful connection to the Internet, the router will retrieve the correct local time from the SNTP server you have specified. If you prefer to specify an SNTP server other than those in the list, simply enter its IP address as shown above. Your ISP may provide an SNTP server for you to use.

Daylight Saving is also known as **Summer Time Period**. Many places in the world adapt it during summer time to move one hour of daylight from morning to the evening in local standard time. Check **Automatic** box to auto set your local time.

Resync Period (in minutes) is the periodic interval the router will wait before it re-synchronizes the router's time with that of the specified SNTP server. In order to avoid unnecessarily increasing the load on your specified SNTP server you should keep the poll interval as high as possible – at the absolute minimum every few hours or even days.

Remote Access

Remote Access	
You may temporarily permit remote administration of this network device	
Allow Access for	<input type="text" value="30"/> minutes.
<input type="button" value="Enable"/>	

To temporarily permit remote administration of the router (i.e. from outside your LAN), select a time period the router will permit remote access for and click **Enable**. You may change other configuration options for the web administration interface using **Device Management** options in the **Advanced** section of the GUI.

If you wish to permanently enable remote access, choose a time period of 0 minutes. This setting cannot be saved into flash when timer set to zero.

Firmware Upgrade

Firmware Upgrade	
You may upgrade the system software on your network device	
New Firmware Image	<input type="text"/> <input type="button" value="Browse..."/>
<input type="button" value="Upgrade"/>	

Your router's "firmware" is the software that allows it to operate and provides all its functionality. Think of your router as a dedicated computer, and the firmware as the software it runs. Over time this software may be improved and modified, and your router allows you to upgrade the software it runs to take advantage of these changes.

Clicking on **Browse** will allow you to select the new firmware image file you have downloaded to your PC. Once the correct file is selected, click Upgrade to update the firmware in your router.



Warning

DO NOT power down the router or interrupt the firmware upgrading while it is still in process. Improper operation could damage the router.

Backup / Restore

Backup/Restore

Allows you to backup the configuration settings to your computer, or restore configuration from your computer.

Backup Configuration

Backup configuration to your computer.

Restore Configuration

Configuration File

"Restore" will overwrite the current configuration and restart the device. If you want to keep the current configuration, please use "Backup" first to save current configuration.

These functions allow you to save and backup your router's current settings to a file on your PC, or to restore a previously saved backup. This is useful if you wish to experiment with different settings, knowing that you have a backup handy in the case of any mistakes. It is advisable to backup your router's settings before making any significant changes to your router's configuration.

Press **Backup** to select where on your local PC to save the settings file. You may also change the name of the file when saving if you wish to keep multiple backups.

Press **Browse** to select a file from your PC to restore. You should only restore settings files that have been generated by the Backup function, and that were created when using the **current version** of the router's firmware. **Settings files saved to your PC should not be manually edited in any way.**

After selecting the settings file you wish to use, pressing **Restore** will load those settings into the router.

Restart Router

Click **Restart** with option **Current Settings** to reboot your router (and restore your last saved configuration).

Restart Router	
After restarting. Please wait for several seconds to let the system	
Restart Router with	<input checked="" type="radio"/> Current Settings
	<input type="radio"/> Factory Default Settings
<input type="button" value="Restart"/>	

If you wish to restart the router using the factory default settings (for example, after a firmware upgrade or if you have saved an incorrect configuration), select **Factory Default Settings** to reset to factory default settings.

You may also reset your router to factory settings by holding the small Reset pinhole button on the back of your router in for 10-12 seconds whilst the router is turned on.

User Management

User Management				
Current Defined Users				
Valid	User	Comment		
true	<i>admin</i>	Default admin user	Edit	
Create				

In order to prevent unauthorized access to your router's configuration interface, it requires all users to login with a password. You can set up multiple user accounts, each with their own password.

You are able to **Edit** existing users and **Create** new users who are able to access the device's configuration interface. Once you have clicked on **Edit**, you are shown the following options:

User Management	
Edit	
Username	admin
Password	<input type="password" value="*****"/>
Confirm	<input type="password" value="*****"/>
Valid	true
Comment	<input type="text" value="Default admin user"/>
<input type="button" value="Apply"/> <input type="button" value="Reset"/>	

You can change the user's **password**, whether their account is active and **Valid**, as well as add a comment to each user account. These options are the same when creating a user account, with the exception that once created you cannot change the username. You cannot delete the default admin account, however you can delete any other created accounts by clicking **Delete** when editing the user.

You are strongly advised to change the password on the default "**admin**" account when you receive your router, and any time you reset your configuration to Factory Defaults.

Firewall and Access Control

Your router includes a full SPI (Stateful Packet Inspection) firewall for controlling Internet access from your LAN, as well as helping to prevent attacks from hackers. In addition to this, when using NAT (Network Address Translation. Please see the **WAN** configuration section for more details on NAT) the router acts as a “natural” Internet firewall, as all PCs on your LAN will use private IP addresses that cannot be directly accessed from the Internet.

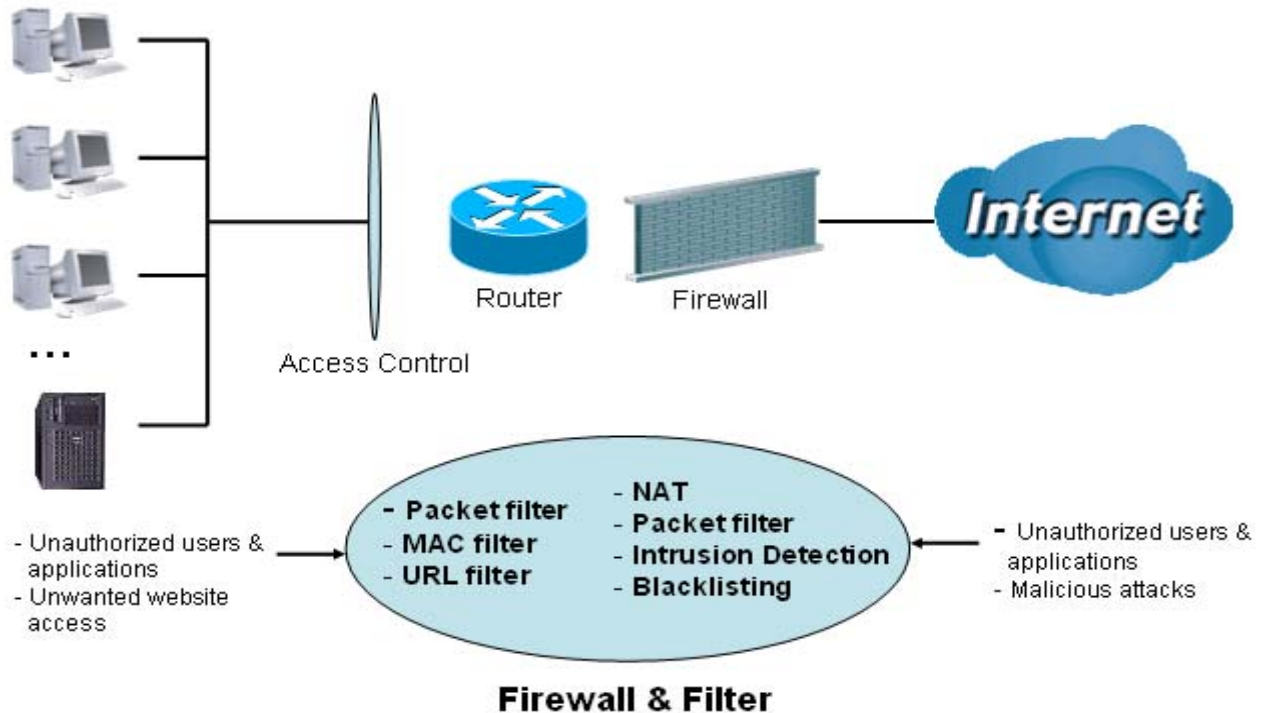

Firewall: Prevents access from outside your network. The router provides three levels of security support:

NAT natural firewall: This masks LAN users’ IP addresses which are invisible to outside users on the Internet, making it much more difficult for a hacker to target a machine on your network. This natural firewall is on when NAT function is enabled.



When using Virtual Servers your PCs will be exposed to the degree specified in your Virtual Server settings provided the ports specified are opened in your firewall packet filter settings.

Firewall Security and Policy (General Settings): Inbound direction of Packet Filter rules to prevent unauthorized computers or applications accessing your local network from the Internet.

Intrusion Detection: Enable Intrusion Detection to detect, prevent and log malicious attacks.

Access Control: Prevents access from PCs on your local network:

Firewall Security and Policy (General Settings): Outbound direction of Packet Filter rules to prevent unauthorized computers or applications accessing the Internet.

URL Filter: To block PCs on your local network from unwanted websites.

You can find six items under the **Firewall** section: [General Settings](#), [Packet Filter](#), [Intrusion Detection](#), [URL Filter](#) and [Firewall Log](#).

General Settings

You can choose not to enable Firewall, to add all filter rules by yourself, or enable the Firewall using preset filter rules and modify the port filter rules as required. The Packet Filter is used to filter packets based-on Applications (Port) or IP addresses.



There are four options when you enable the Firewall, they are:

- ⊙ **All blocked/User-defined:** no pre-defined port or address filter rules by default, meaning that all inbound (Internet to LAN) and outbound (LAN to Internet) packets will be blocked. Users have to add their own filter rules for further access to the Internet.
- ⊙ **High/Medium/Low security level:** the predefined port filter rules for High, Medium and Low security are displayed in Port Filters of Packet Filter.

Select either **High, Medium** or **Low security level** to enable the Firewall. The only difference between these three security levels is the preset port filter rules in the Packet Filter. Firewall functionality is the same for all levels; it is only the list of preset port filters that changes between each setting. For more detailed on level of preset port filter information, refer to **Table 1: Predefined Port Filter**.

If you choose of the preset security levels and then add custom filters, you may temporarily disable the firewall and recover your custom filter settings by re-selecting the same security level.

The **“Block WAN Request”** is a stand-alone function and not relate to whether security enable or disable. Mostly it is for preventing any scan tools from WAN site by hacker.

General Settings	
Firewall Security	
Security	<input type="radio"/> Enable <input checked="" type="radio"/> Disable
Policy	All blocked/User-defined
	High security level
	<input checked="" type="radio"/> Medium security level
	Low security level
<p>( If some applications cannot work after enabling Firewall, please check the Packet Filter especially Port Filter rules. For example, adding (TCP:443,outbound allowed) will let HTTPS data go through Firewall.)</p>	
Block WAN Request	<input type="radio"/> Enable <input checked="" type="radio"/> Disable
<p>( Enable for preventing any ping test from Internet, such as hacker attack.)</p>	
<input type="button" value="Apply"/>	

NOTE:

Any remote user who is attempting to perform this action may result in blocking all the accesses to configure and manage of the device from the Internet.

Packet Filter

This function is only available when the Firewall is enabled and one of these four security levels is chosen (All blocked, High, Medium and Low). The predefined port filter rules in the Packet Filter must modify accordingly to the level of Firewall, which is selected. See **Table1: Predefined Port Filter** for more detailed information.

Packet Filter	
Add TCP/UDP Filter ▶	Add Raw IP Filter ▶

Packet Filter Rules							
Rule Name	Time Schedule	Source IP / Netmask	Protocol	Source port(s)	Inbound	Edit ▶	Delete ▶
		Destination IP / Netmask		Destination port(s)	Outbound		
lei_http	Always On	0.0.0.0 / 0.0.0.0	TCP	0 ~ 65535	Block	Edit ▶	Delete ▶
		0.0.0.0 / 0.0.0.0		80 ~ 80	Allow		
lei_dns	Always On	0.0.0.0 / 0.0.0.0	UDP	0 ~ 65535	Block	Edit ▶	Delete ▶
		0.0.0.0 / 0.0.0.0		53 ~ 53	Allow		
lei_tdns	Always On	0.0.0.0 / 0.0.0.0	TCP	0 ~ 65535	Block	Edit ▶	Delete ▶
		0.0.0.0 / 0.0.0.0		53 ~ 53	Allow		
lei_ftp	Always On	0.0.0.0 / 0.0.0.0	TCP	0 ~ 65535	Block	Edit ▶	Delete ▶
		0.0.0.0 / 0.0.0.0		21 ~ 21	Allow		
lei_tnet	Always On	0.0.0.0 / 0.0.0.0	TCP	0 ~ 65535	Block	Edit ▶	Delete ▶
		0.0.0.0 / 0.0.0.0		23 ~ 23	Allow		
lei_smtp	Always On	0.0.0.0 / 0.0.0.0	TCP	0 ~ 65535	Block	Edit ▶	Delete ▶
		0.0.0.0 / 0.0.0.0		25 ~ 25	Allow		
lei_pop3	Always On	0.0.0.0 / 0.0.0.0	TCP	0 ~ 65535	Block	Edit ▶	Delete ▶
		0.0.0.0 / 0.0.0.0		110 ~ 110	Allow		

Example: Predefined Port Filters Rules

The predefined port filter rules for High, Medium and Low security levels are listed. See Table 1.

(Note: Firewall – All Blocked/User-defined, you must define and create the port filter rules yourself. No predefined rule is set)

Table 1: Predefined Port Filter

Application	Protocol	Port Number		Firewall - High		Firewall - Medium		Firewall – Low	
		Start	End	Inbound	Outbound	Inbound	Outbound	Inbound	Outbound
HTTP(80)	TCP(6)	80	80	NO	YES	NO	YES	NO	YES
DNS (53)	UDP(17)	53	53	NO	YES	NO	YES	YES	YES
DNS (53)	TCP(6)	53	53	NO	YES	NO	YES	YES	YES
FTP(21)	TCP(6)	21	21	NO	NO	NO	YES	NO	YES
Telnet(23)	TCP(6)	23	23	NO	NO	NO	YES	NO	YES
SMTP(25)	TCP(6)	25	25	NO	YES	NO	YES	NO	YES
POP3(110)	TCP(6)	110	110	NO	YES	NO	YES	NO	YES
NEWS(119)	TCP(6)	119	119	NO	NO	NO	YES	NO	YES
RealAudio (7070)	UDP(17)	7070	7070	NO	NO	YES	YES	YES	YES
PING	ICMP(1)	N/A	N/A	NO	YES	NO	YES	NO	YES
H.323(1720)	TCP(6)	1720	1720	NO	NO	NO	YES	YES	YES
T.120(1503)	TCP(6)	1503	1503	NO	NO	NO	YES	YES	YES
SSH(22)	TCP(6)	22	22	NO	NO	NO	YES	YES	YES
NTP(123)	UDP(17)	123	123	NO	YES	NO	YES	NO	YES
HTTPS(443)	TCP(6)	443	443	NO	NO	NO	YES	NO	YES
ICQ (5190)	TCP(6)	5190	5190	NO	NO	NO	NO	YES	YES

Inbound: Internet to LAN

Outbound: LAN to Internet.

Packet Filter – Add TCP/UDP Filter

Packet Filter			
Add TCP/UDP Filter			
Rule Name	<input type="text"/>		
Time Schedule	Always On <input type="button" value="v"/>		
Source IP Address(es)	<input type="text" value="0.0.0.0"/>	Netmask	<input type="text" value="0.0.0.0"/>
Destination IP Address(es)	<input type="text" value="0.0.0.0"/>	Netmask	<input type="text" value="0.0.0.0"/>
Type	TCP <input type="button" value="v"/>		
Source Port	<input type="text" value="0"/> - <input type="text" value="65535"/>		
Destination Port	<input type="text" value="0"/> - <input type="text" value="65535"/>		
Inbound	Allow <input type="button" value="v"/>		
Outbound	Allow <input type="button" value="v"/>		
<input type="button" value="Apply"/> <input type="button" value="Return"/> <input type="button" value="▶"/>			

Rule Name: A user-defined name for identifying the application.

Time Schedule: It is self-defined time period. You may specify a time schedule for your prioritization policy. For setup and detail, refer to **Time Schedule** section

Source IP Address(es) / Destination IP Address(es): This is the Address-Filter used to allow or block traffic to/from particular IP address(es). Selecting the **Subnet Mask** of the IP address range you wish to allow/block the traffic to or from; set IP address and Subnet Mask to **0.0.0.0** to inactive the Address-Filter rule.

Tip: To block access, to/from a single IP address, enter that IP address as the **Host IP Address** and use a **Host Subnet Mask** of "255.255.255.255".

Type: It is the packet protocol type used by the application, select either **TCP** or **UDP**.

Source Port: This Port or Port Ranges defines the port allowed to be used by the Remote/WAN to connect to the application. Default is set from range **0 ~ 65535**. It is recommended that this option be configured by an advanced user.

Destination Port: This is the Port or Port Ranges that defines the application.

Inbound / Outbound: Select **Allow** or **Block** the access to the Internet ("Outbound") or from the Internet ("Inbound").

Click **Apply** button to apply your changes.

Packet Filter – Add Raw IP Filter

Packet Filter	
Add Raw IP Filter	
Rule Name	<input type="text"/>
Time Schedule	Always On ▼
Protocol Number	<input type="text"/>
Inbound	Allow ▼
Outbound	Allow ▼
<input type="button" value="Apply"/> <input type="button" value="Return"/>	

Rule Name: A user-defined name for identifying the rule.

Time Schedule: It is self-defined time period. You may specify a time schedule for your prioritization policy. For setup and detail, refer to **Time Schedule** section

Protocol Number: Insert the port number, i.e. GRE 47.

Inbound / Outbound: Select **Allow** or **Block** the access to the Internet (“**Outbound**”) or from the Internet (“**Inbound**”).

Click **Apply** button to apply your changes.

Example: Configuring your firewall to allow for a publicly accessible web server on your LAN

The predefined port filter rule for HTTP (TCP port 80) is the same no matter whether the firewall is set to a high, medium or low security level. To setup a web server located on the local network when the firewall is enabled, you have to configure the Port Filters setting for HTTP.

As you can see from the diagram below, when the firewall is enabled with one of the three presets (Low/Medium/High), inbound HTTP access is not allowed which means remote access through HTTP to your router is not allowed.

(Note: Inbound indicates accessing from Internet to LAN and Outbound is from LAN to the Internet)

Packet Filter Rules							
Rule Name	Time Schedule	Source IP / Netmask	Protocol	Source port(s)	Inbound	Edit	Delete
		Destination IP / Netmask		Destination port(s)	Outbound		
mei_http	Always On	0.0.0.0 / 0.0.0.0	TCP	0 ~ 65535	Block	Edit	Delete
		0.0.0.0 / 0.0.0.0		80 ~ 80	Allow		
mei_dns	Always On	0.0.0.0 / 0.0.0.0	UDP	0 ~ 65535	Block	Edit	Delete
		0.0.0.0 / 0.0.0.0		53 ~ 53	Allow		
mei_tdns	Always On	0.0.0.0 / 0.0.0.0	TCP	0 ~ 65535	Block	Edit	Delete
		0.0.0.0 / 0.0.0.0		53 ~ 53	Allow		
mei_ftp	Always On	0.0.0.0 / 0.0.0.0	TCP	0 ~ 65535	Block	Edit	Delete
		0.0.0.0 / 0.0.0.0		21 ~ 21	Allow		
mei_tnet	Always On	0.0.0.0 / 0.0.0.0	TCP	0 ~ 65535	Block	Edit	Delete
		0.0.0.0 / 0.0.0.0		23 ~ 23	Allow		
mei_smtp	Always On	0.0.0.0 / 0.0.0.0	TCP	0 ~ 65535	Block	Edit	Delete
		0.0.0.0 / 0.0.0.0		25 ~ 25	Allow		
mei_pop3	Always On	0.0.0.0 / 0.0.0.0	TCP	0 ~ 65535	Block	Edit	Delete
		0.0.0.0 / 0.0.0.0		110 ~ 110	Allow		
mei_nnpt	Always On	0.0.0.0 / 0.0.0.0	TCP	0 ~ 65535	Block	Edit	Delete
		0.0.0.0 / 0.0.0.0		119 ~ 119	Allow		

Configuring Packet Filter:

1. Click **Port Filters**. You will then be presented with the predefined port filter rules screen (in this case for the low security level), shown below:

Note: You may click **Edit** the predefined rule instead of **Delete** it. This is an example to show to how you add a filter on your own.

Packet Filter							
Add TCP/UDP Filter ▶				Add Raw IP Filter ▶			
Packet Filter Rules							
Rule Name	Time Schedule	Source IP / Netmask	Protocol	Source port(s)	Inbound	Click Delete	
		Destination IP / Netmask		Destination port(s)	Outbound		
mei_http	Always On	0.0.0.0 / 0.0.0.0	TCP	0 ~ 65535	Block	Edit ▶	Delete ▶
		0.0.0.0 / 0.0.0.0		80 ~ 80	Allow		
mei_dns	Always On	0.0.0.0 / 0.0.0.0	UDP	0 ~ 65535	Block	Edit ▶	Delete ▶
		0.0.0.0 / 0.0.0.0		53 ~ 53	Allow		
mei_tdns	Always On	0.0.0.0 / 0.0.0.0	TCP	0 ~ 65535	Block	Edit ▶	Delete ▶
		0.0.0.0 / 0.0.0.0		53 ~ 53	Allow		
mei_ftp	Always On	0.0.0.0 / 0.0.0.0	TCP	0 ~ 65535	Block	Edit ▶	Delete ▶
		0.0.0.0 / 0.0.0.0		21 ~ 21	Allow		
mei_tnet	Always On	0.0.0.0 / 0.0.0.0	TCP	0 ~ 65535	Block	Edit ▶	Delete ▶
		0.0.0.0 / 0.0.0.0		23 ~ 23	Allow		

2. Click **Delete** to delete the existing HTTP rule.
3. Click **Add TCP/UDP Filter**.

Click Add TCP/UDP Filter

Port Filters		
Filtering Rules		
Add TCP/UDP Filter ▶	Add Raw IP Filter ▶	Return ▶

4. Input the Rule Name, Time Schedule, Source/Destination IP, Type, Source/Destination Port, Inbound and Outbound.

Example:

Application: *Cindy_HTTP*

Time Schedule: *Always On*

Source / Destination IP Address(es): *0.0.0.0 (I do not wish to active the address-filter, instead I use the port-filter)*

Type: *TCP (Please refer to Table1: Predefined Port Filter)*

Source Port: *0-65535 (I allow all ports to connect with the application))*

Redirect Port: *80-80 (This is Port defined for HTTP)*

Inbound / Outbound: *Allow*

Packet Filter

Add TCP/UDP Filter

Rule Name	Cindy_HTTP		
Time Schedule	Always On ▾		
Source IP Address(es)	0.0.0.0	Netmask	0.0.0.0
Destination IP Address(es)	0.0.0.0	Netmask	0.0.0.0
Type	TCP ▾		
Source Port	0 - 65535		
Destination Port	80 - 80		
Inbound	Allow ▾		
Outbound	Allow ▾		

[Apply](#) [Return](#) ▶

5. The new port filter rule for HTTP is shown below:

Cindy_HTTP	Always On	0.0.0.0 / 0.0.0.0	TCP	0 ~ 65535	Allow	Edit ▶	Delete ▶
		0.0.0.0 / 0.0.0.0		80 ~ 80	Allow		

7. Configure your Virtual Server (“port forwarding”) settings so that incoming HTTP requests on port 80 will be forwarded to the PC running your web server:

Note: For how to configure the HTTP in Virtual Server, go to **Add Virtual Server** in **Virtual Server** section for more details.

Virtual Server (Port Forwarding)

[Add Virtual Server](#) ▶ [Edit DMZ Host](#) ▶ [Edit One-to-one NAT](#) ▶

Virtual Server Table

Application	Time Schedule	Protocol	External Port	Redirect Port	IP Address		
HTTP_Server	Always On	tcp	80 - 80	80 - 80	192.168.1.254	Edit ▶	Delete ▶

Intrusion Detection

Intrusion Detection	
Parameters	
Intrusion Detection	<input type="radio"/> Enable <input checked="" type="radio"/> Disable
Victim Protection Block Duration	<input type="text" value="600"/> seconds
Scan Attack Block Duration	<input type="text" value="86400"/> seconds
DOS Attack Block Duration	<input type="text" value="1800"/> seconds
Maximum TCP Open Handshaking Count	<input type="text" value="100"/> per second
Maximum Ping Count	<input type="text" value="15"/> per second
Maximum ICMP Count	<input type="text" value="100"/> per second
<input type="button" value="Apply"/>	
<input type="button" value="Clear Blacklist"/>	

The router's *Intrusion Detection System* (IDS) is used to detect hacker attacks and intrusion attempts from the Internet. If the IDS function of the firewall is enabled, inbound packets are filtered and blocked depending on whether they are detected as possible hacker attacks, intrusion attempts or other connections that the router determines to be suspicious.

Blacklist: If the router detects a possible attack, the source IP or destination IP address will be added to the Blacklist. Any further attempts using this IP address will be blocked for the time period specified as the **Block Duration**. The default setting for this function is false (disabled). Some attack types are denied immediately without using the Blacklist function, such as *Land attack* and *Echo/CharGen scan*.

Intrusion Detection: If enabled, IDS will block Smurf attack attempts. Default is false.

Block Duration:

- ⊙ **Victim Protection Block Duration:** This is the duration for blocking *Smurf* attacks. Default value is 600 seconds.
- ⊙ **Scan Attack Block Duration:** This is the duration for blocking hosts that attempt a possible Scan attack. Scan attack types include *X'mas scan*, *IMAP SYN/FIN scan* and similar attempts. Default value is 86400 seconds.
- ⊙ **DoS Attack Block Duration:** This is the duration for blocking hosts that attempt a possible Denial of Service (DoS) attack. Possible DoS attacks this attempts to block include *Ascend Kill* and *WinNuke*. Default value is 1800 seconds.

Max TCP Open Handshaking Count: This is a threshold value to decide whether a *SYN Flood* attempt is occurring or not. Default value is 100 TCP SYN per seconds.

Max PING Count: This is a threshold value to decide whether an *ICMP Echo Storm* is occurring or not. Default value is 15 ICMP Echo Requests (PING) per second.

Max ICMP Count: This is a threshold to decide whether an *ICMP flood* is occurring or not. Default value is 100 ICMP packets per seconds except ICMP Echo Requests (PING).

For *SYN Flood*, *ICMP Echo Storm* and *ICMP flood*, IDS will just warn the user in the Event Log. It cannot protect against such attacks.

Table 2: Hacker attack types recognized by the IDS

Intrusion Name	Detect Parameter	Blacklist	Type of Block Duration	Drop Packet	Show Log
Ascend Kill	Ascend Kill data	Src IP	DoS	Yes	Yes
WinNuke	TCP Port 135, 137~139, Flag: URG	Src IP	DoS	Yes	Yes
Smurf	ICMP type 8 Des IP is broadcast	Dst IP	Victim Protection	Yes	Yes
Land attack	SrcIP = DstIP			Yes	Yes
Echo/CharGen Scan	UDP Echo Port and CharGen Port			Yes	Yes
Echo Scan	UDP Dst Port = Echo(7)	Src IP	Scan	Yes	Yes
CharGen Scan	UDP Dst Port = CharGen(19)	Src IP	Scan	Yes	Yes
X'mas Tree Scan	TCP Flag: X'mas	Src IP	Scan	Yes	Yes
IMAP SYN/FIN Scan	TCP Flag: SYN/FIN DstPort: IMAP(143) SrcPort: 0 or 65535	Src IP	Scan	Yes	Yes
SYN/FIN/RST/ACK Scan	TCP, No Existing session And Scan Hosts more than five.	Src IP	Scan	Yes	Yes
Net Bus Scan	TCP No Existing session DstPort = Net Bus 12345, 12346, 3456	SrcIP	Scan	Yes	Yes
Back Orifice Scan	UDP, DstPort = Orifice Port (31337)	SrcIP	Scan	Yes	Yes
SYN Flood	Max TCP Open Handshaking Count (Default 100 c/sec)				Yes
ICMP Flood	Max ICMP Count (Default 100 c/sec)				Yes
ICMP Echo	Max PING Count (Default 15 c/sec)				Yes

Src IP: Source IP
Dst Port: Destination Port

Src Port: Source Port
Dst IP: Destination IP

URL Filter

URL (Uniform Resource Locator – e.g. an address in the form of <http://www.abcde.com> or <http://www.example.com>) filter rules allow you to prevent users on your network from accessing particular websites by their URL. There are no pre-defined URL filter rules; you can add filter rules to meet your requirements.

URL Filter	
Configuration	
URL Filtering	<input type="radio"/> Enable <input checked="" type="radio"/> Disable
Block Mode	Disabled ▾
Keywords Filtering	<input type="checkbox"/> Enable Details ▶
Domains Filtering	<input type="checkbox"/> Enable Details ▶
	<input type="checkbox"/> Disable all WEB traffic except for Trusted Domains
Restrict URL Features	<input type="checkbox"/> Block Java Applet
	<input type="checkbox"/> Block surfing by IP address
<input type="button" value="Apply"/> <input type="button" value="Cancel"/>	

Enable/Disable: To enable or disable URL Filter feature.

Block Mode: A list of the modes that you can choose to check the URL filter rules. The default is set to **Disabled**.

⊙ **Disabled:** No action will be performed by the Block Mode.

⊙ **Always On:** Action is enabled. URL filter rules will be monitoring and checking at all hours of the day.

⊙ **TimeSlot1 ~ TimeSlot16:** It is self-defined time period. You may specify the time period to check the URL filter rules, i.e. during working hours. For setup and detail, refer to **Time Schedule** section.

Keywords Filtering: Allows blocking by specific keywords within a particular URL rather than having to specify a complete URL (e.g. to block any image called “advertisement.gif”). When enabled, your specified keywords list will be checked to see if any keywords are present in URLs accessed to determine if the connection attempt should be blocked. Please note that the URL filter blocks web browser (HTTP) connection attempts using port 80 only.

For example, if the URL is <http://www.abc.com/abcde.html>, it will be dropped as the keyword “abcde” occurs in the URL.

Keywords Filtering

Create

Keyword

Apply

Block WEB URLs which contain these keywords

Name	Keyword	
item0	abcde	Delete

Domains Filtering: This function checks the domain name only, not the IP address, in URLs accessed against your list of domains to block or allow. If it is matched, the URL request will be sent (Trusted) or dropped (Forbidden). For this function to be activated, **both check-boxes must be checked**. The checking procedure is:

1. Check the domain in the URL to determine if it is in the trusted list. If yes, the connection attempt is sent to the remote web server.
2. If not, check if it is listed in the forbidden list, and if present then the connection attempt is dropped.
3. If the packet does not match either of the above two items, it is sent to the remote web server.
4. Please be note that the domain only should be specified, not the full URL. For example to block traffic to www.sex.com, enter “sex” or “sex.com” instead of “www.sex.com”. In the example below, the URL request for www.abc.com will be sent to the remote web server because it is listed in the trusted list, whilst the URL request for www.sex or www.sex.com will be dropped, because sex.com is in the forbidden list.

Domains Filtering

Domain Name

Domain Name

sex

Type

Forbidden Domain

Forbidden Domain

Trusted Domain

Apply

Trusted Domain

Name

Domain

item1

abc

Delete

Forbidden Domain

Name

Domain

item0

sex

Delete

Return

Restrict URL Features: This function enhances the restriction to your URL rules.

Example: Andy wishes to disable all WEB traffic except for ones listed in the trusted domain, which would prevent Bobby from accessing other web sites.

Andy selects both functions in the *Domain Filtering* and thinks that it will stop Bobby. But Bobby knows this function, *Domain Filtering*, ONLY disables all WEB traffic except for **Trusted Domain**, BUT not its **IP address**. If this is the situation, **Block surfing by IP address** function can be handy and helpful to Andy. Now, Andy can prevent Bobby from accessing other sites.

Ⓞ **Block Java Applet:** This function can block Web content that includes the Java Applet. It is to prevent someone who wants to damage your system via standard HTTP protocol.

Ⓞ **Block surfing by IP address:** Preventing someone who uses the IP address as URL for skipping **Domains Filtering** function. Activates only and if *Domain Filtering* enabled.

Firewall Log

Firewall Log	
Event will be shown in the Status - Event Log	
Filtering Log	<input type="radio"/> Enable <input checked="" type="radio"/> Disable
Intrusion Log	<input type="radio"/> Enable <input checked="" type="radio"/> Disable
URL Blocking Log	<input type="radio"/> Enable <input checked="" type="radio"/> Disable

Firewall Log display log information of any unexpected action with your firewall settings.

Check the **Enable** box to activate the logs.

Log information can be seen in the **Status – Event Log** after enabling.

VoIP (Voice over Internet Protocol)

VoIP enables telephone calls through existing Internet connection instead of going through the PSTN (Public Switched Telephone Network). It is not only cost-effective, especially for a long distance telephone charges, but also toll-quality voice calls over the Internet.



Attention

*After completing VoIP configuration, remember to **apply** the changes, **SAVE CONFIG** and **restart** to activate your VoIP.*

There are four items within the **VoIP** section: **Wizard**, **General Settings**, **Phone Configuration** and **PSTN Dial Plan**.

Wizard

This section provides easy setup for your VoIP service. Phone port 1 and 2 can be registered to different SIP Service Provider.

VoIP Wizard	
Voice QoS	
DSCP Marking	Best Effort <input type="button" value="v"/>
Setting for Phone Port 1	
SIP Service Provider	FWD <input type="button" value="v"/>
Phone Number	<input type="text"/>
Authentication Username	<input type="text"/>
Authentication Password	<input type="text"/>
Setting for Phone Port 2	
SIP Service Provider	FWD <input type="button" value="v"/>
Phone Number	<input type="text"/>
Authentication Username	<input type="text"/>
Authentication Password	<input type="text"/>
 <i>Caution! The VoIP configuration will take effect only when you apply the changes, save configuration and restart the device.</i>	
<input type="button" value="Apply"/> <input type="button" value="Cancel"/>	

Voice QoS

DSCP: Differentiated Services Code Point (DSCP), it is the first 6 bits in the ToS byte. DSCP Marking allows users to classify traffic based on DSCP value and send packets to next Router.

Setting for Phone Port 1

SIP Service Provider: This section allows you to select the service provider. When the selection is done, respective parameters below are automatically displayed.

Phone Number: This parameter holds the registration ID of the user within the SIP registrar.

Authentication Username: Same as Phone Number.

Authentication Password: This parameter holds the password used for authentication within SIP registrar.

Setting for Phone Port 2

Please refer to the description of “Setting for Phone Port 1”.

General Configuration

This section contains the basic settings for the VoIP module. Fail to provide correct information will halt making calls out to the Internet.

General Settings	
SIP Device Parameters	
SIP	<input checked="" type="radio"/> Enable <input type="radio"/> Disable
RTP Port	<input type="text" value="5100"/>
Region	<input type="text" value="US"/>
Voice QoS, DSCP Marking	<input type="text" value="Best Effort"/>
Setting for Phone Port 1	
Registrar Address(or Hostname)	<input type="text"/>
Registrar Port	<input type="text" value="5060"/>
Expire	<input type="text" value="3600"/> seconds
User Domain/Realm	<input type="text"/> (If empty, it is the same as Registrar Address.)
Outbound Proxy Address	<input type="text"/> (If empty, it is the same as Registrar Address.)
Outbound Proxy Port	<input type="text" value="5060"/>
Setting for Phone Port 2	
Registrar Address(or Hostname)	<input type="text"/>
Registrar Port	<input type="text" value="5060"/>
Expire	<input type="text" value="3600"/> seconds
User Domain/Realm	<input type="text"/> (If empty, it is the same as Registrar Address.)
Outbound Proxy Address	<input type="text"/> (If empty, it is the same as Registrar Address.)
Outbound Proxy Port	<input type="text" value="5060"/>
 <i>Caution! The VoIP configuration will take effect only when you apply the changes, save configuration and restart the device.</i>	
<input type="button" value="Apply"/> <input type="button" value="Cancel"/>	

SIP Device Parameters

SIP: To use SIP as VoIP call signaling protocol.

RTP Port: Provide the based value from the media (RTP) ports that are assigned for various endpoints and the different call sessions that may exist within an end-point. (Range from 5100 to 65535, default value is 5100)

Region: This selection is a drop-down box, which allows user to select the country for which the VoIP device must work. When a country is selected, the country parameters are automatically loaded.

Voice QoS, DSCP Marking: Differentiated Services Code Point (DSCP), it is the first 6 bits in the ToS byte. DSCP Marking allows users to classify traffic based on DSCP value and send packets to next Router.

Setting for Phone Port 1

Registrar Address(or Hostname): Indicate the SIP registrar IP address.

Registrar Port: Specify the port of the SIP registrar on which it will listen for register requests from VoIP device.

Expire: Expire time for the registration message sending.

User Domain/Realm: Set different domain name for the SIP proxy server.

Outbound Proxy Address: Indicate the SIP outbound proxy server IP address. This parameter is very useful when VoIP device is behind a NAT.

Outbound Proxy Port: Specify the port of the SIP outbound proxy on which it will listen for messages.

Setting for Phone Port 2

Please refer to the description of “Setting for Phone Port 1”.

Phone Configuration

This section displays status and allows you to edit the account information of your Phones. Click **Edit** to update your phone information.

Phone Configuration				
Phone Port				
Index	Phone Number	Display Name	Registered	
1			unknown	Edit ▶
2			unknown	Edit ▶

 *Caution! The VoIP configuration will take effect only when you apply the changes, save configuration and restart the device.*

Phone Port 1	
Login Account Configuration	
Phone Number	<input type="text"/>
Authentication Username	<input type="text"/>
Authentication Password	<input type="text"/>
Confirm Password	<input type="text"/>
Display Name	<input type="text"/>
Codec Preference	
Priority 1	G.729 ▼
Priority 2	PCMU (G.711 u-Law) ▼
Priority 3	PCMA (G.711 A-Law) ▼
Speed Dial	
2#	<input type="text"/>
3#	<input type="text"/>
4#	<input type="text"/>
5#	<input type="text"/>
6#	<input type="text"/>
7#	<input type="text"/>
8#	<input type="text"/>
9#	<input type="text"/>
<input type="button" value="Apply"/> <input type="button" value="Cancel"/>	

Login Account Configuration

Phone Number: This parameter holds the registration ID of the user within the SIP registrar.

Authentication Username: Same as Phone Number.

Authentication Password: This parameter holds the password used for authentication within SIP registrar.

Confirm Password: Re-enter the password for confirmation.

Display Name: This parameter will be appeared on the Caller ID.

Codec Preference

Codec is known as Coder-Decoder used for data signal conversion. Set the priority of voice compression; Priority 1 owns the top priority.

G.711 μ -LAW: It is a basic non-compressed encoder and decoder technique. μ -LAW uses pulse code modulation (PCM) encoder and decoder to convert 14-bit linear sample. 64kbps bandwidth is needed.

G.711A-LAW: It is a basic non-compressed encoder and decoder technique. μ -LAW uses pulse code modulation (PCM) encoder and decoder to convert 13-bit linear sample. 64kbps bandwidth is needed.

G.729: it is used to encoder and decoder voice information into a single packet which reduces the bandwidth consumption. 8kbps bandwidth is needed.

Note: Codec priority is assigned in the order as G.729 > G.711 μ -LAW > G.711A-LAW

Speed Dial

It is for you to store frequently used telephone numbers which you can press number from 0 to 9 and the pound sign (#) to activate this function. For example, speed dial to phone number lists on 9, just press **9** then **#**. Your router will automatically call out to number listed on entry 9.

Indicate remote user's IP address or domain name if this remote user does not register in the SIP server. If remote user is registered in the SIP server, this field is related to the SIP server's IP / Domain name.

For examples:

If your friend Tim gives you a SIP URL as sip: 89755@192.246.69.223 then you can fill in as 89755@192.246.69.223.

If your friend Felix gives you a SIP URL as sip: felix@iptel.org then you can fill in as felix@iptel.org.

If your friend Greg gives you an IP address "192.246.56.56" only, then you can fill in as "192.246.56.56". In case, some of users may use DDNS, you can fill in with domain name as well.

PSTN Dial Plan (7402VGP only)

This section enables you to configure “VoIP with PSTN switching” on your system. You can define a range of dial plans that specify the numbers that are connected to the PSTN. If the number dialed matches a number defined in the dial plan, then the number is routed to the PSTN. Otherwise, the number is routed to the VoIP network.

PSTN Dial Plan

Add Entry 

Dial Plan

Prefix	Number of Digits	Action		
--------	------------------	--------	--	--

Add Dial Plan Entry**Parameters**

Prefix	<input type="text"/>
Number of Digits	<input type="text"/> (15:at most)
Action	Dial with Prefix 

Apply Cancel Return 

Prefix: Specify the numbers that are connected to the PSTN.

Number of Digits: The number of other digits to be collected before dialing.

Action:

- Dial with Prefix:** Dial the entire dialed number including the prefix.
- Dial without Prefix:** Dial only the **Number of Digits** and not the prefix.
- Dial at Timeout:** Dial the digits collected so far after a timeout. (The timeout starts when no more digits have been dialed for a specific amount of time).

For Example:**Add Dial Plan Entry****Parameters**

Prefix	01223 <input type="text"/>
Number of Digits	6 <input type="text"/> (0..15)
Action	Dial with Prefix 

Apply Cancel Return 

Means that if the user dials 01223 707070, the number 01223 707070 is dialed on the PSTN.

Add Dial Plan Entry

Parameters

Prefix	<input type="text" value="9"/>
Number of Digits	<input type="text" value="3"/> (0..15)
Action	<input type="text" value="Dial without Prefix"/> ▼

Means that if the user dials 9102, the number 102 is dialed on the PSTN.

Add Dial Plan Entry

Parameters

Prefix	<input type="text" value="01223"/>
Number of Digits	<input type="text" value="6"/> (0..15)
Action	<input type="text" value="Dial at Timeout"/> ▼

Means that if the user dials 01223 7070 and dials no further numbers, then after the timeout has expired the number will be dialed on the PSTN - even though six digits have not been dialed. The user can dial a maximum number of six digits and the number will be dialed after the timeout.



Attention

The following situation will make phone port 1 and 2 relay to PSTN line automatically.

- **Power down**
- **Internet Service fail**
- **SIP service is not available**

Special dial codes

The following table lists the special dial codes that are built-in to the system:

Option	Description
<p>Flash-hook (7402VGP only)</p>	<p>Switch to PSTN line</p> <p>Note: A quick press of the hook. On some phones a button is provided which provides Flash-hook functionality. The button is marked "FLASH" or "RECALL".</p>
<p>*69</p>	<p>Return the last missed call for SIP service only</p> <p>Note: Entering this on a phone will call the last number which made a call to the phone. For example A makes a call to B, but hangs up before B answers. If B enters *69, A will be called.</p>
<p>##</p>	<p>Last number redial</p>
<p>*20</p>	<p>Set do not disturb on</p> <p>Note: It is possible to set a Do-Not-Disturb feature on a phone such that any phone which calls the phone will receive an engaged tone and the phone called will not ring. For example, B enters *20 and hangs up. A makes a call to B, and receives the engaged tone and phone B does not ring.</p>
<p>*80</p>	<p>Set do not disturb off</p>
<p>*74<x><number>#</p>	<p>Set the number for Speeddial code 'x', where 'x' is a number between 2 and 9.</p> <p>Note: Where <x> is a number between 2 and 9, and <number> is the number to dial. The code needed to dial a speeddial from a phone connected to a VoIP Router is:</p> <p><x>#, where <x> is a number between 2 and 9.</p> <p>The settings will infect to your setting in Speed Dial on WEB GUI.</p>
<p>*90<phone-number></p>	<p>Set the number for performing Blind Call Transfer, where <phone-number> is the number that you wish to transfer the call to. It's for SIP service only.</p> <p>Note: In Blind Call Transfer, you have a call in progress (incoming or outgoing) and decide you wish to transfer the call to another phone. To transfer the call, perform the following steps:</p> <ol style="list-style-type: none"> 1. Hook-flash to get a dial tone. 2. Dial *90<phone-number> (e.g. *907401), there will be a confirmation tone then hang up. The other end will hear ring back and the called third-party phone will ring. When the third-party phone is picked up the two calls will be connected. <p>If the third-party phone does not answer then the caller being transferred can hang up to cancel the connect attempt.</p>

QoS (Quality of Service)

QoS function helps you to control your network traffic for each application from LAN (Ethernet and/or Wireless) to WAN (Internet). It facilitates you to control the different quality and speed of through put for each application when the system is running with full loading of upstream.

You can find three items under the **QoS** section: **Prioritization** and **Outbound / Inbound IP Throttling** (bandwidth management).

Prioritization

There are three priority settings to be provided in the Router:

- ⊙ **High**
- ⊙ **Normal** (The default is normal priority for all of traffic without setting)
- ⊙ **Low**

And the balances of utilization for each priority are High (60%), Normal (30%) and Low (10%).

Prioritization						
Configuration (from LAN to WAN packet)						
Application	Time Schedule	Priority	Protocol	Source Port	Source IP Address Range (‘0.0.0.0’ means Any)	DSCP Marking
				Destination Port	Destination IP Address Range (‘0.0.0.0’ means Any)	
PPTP	Always On	High	GRE	none	0.0.0.0 ~ 0.0.0.0	Gold service (L)
				none	0.0.0.0 ~ 0.0.0.0	
VoIP	Always On	High	any	0 ~ 0	192.168.1.1 ~ 192.168.1.1	Gold service (L)
				0 ~ 0	0.0.0.0 ~ 0.0.0.0	
Restricted	TimeSlot1	Low	any	0 ~ 0	192.168.1.100 ~ 192.168.1.100	Gold service (L)
				0 ~ 0	0.0.0.0 ~ 0.0.0.0	
	Always On	High	any	0 ~ 0	0.0.0.0 ~ 0.0.0.0	Disabled
				0 ~ 0	0.0.0.0 ~ 0.0.0.0	
	Always On	High	any	0 ~ 0	0.0.0.0 ~ 0.0.0.0	Disabled
				0 ~ 0	0.0.0.0 ~ 0.0.0.0	
	Always On	High	any	0 ~ 0	0.0.0.0 ~ 0.0.0.0	Disabled
				0 ~ 0	0.0.0.0 ~ 0.0.0.0	
	Always On	High	any	0 ~ 0	0.0.0.0 ~ 0.0.0.0	Disabled
				0 ~ 0	0.0.0.0 ~ 0.0.0.0	

Application: A user-define description to identify this new policy/application.

Time Schedule: Scheduling your prioritization policy.

Priority: The priority given to each policy/application. Its default setting is set to High; you may adjust this setting to fit your policy/application.

Protocol: The name of supported protocol.

Source Port: The source port of packets to be monitored.

Destination Port: The destination port of packets to be monitored.

Source IP Address Range: The source IP address or range of packets to be monitored.

Destination IP address Range: The destination IP address or range of packets to be monitored.

DSCP Marking: Differentiated Services Code Point (DSCP), it is the first 6 bits in the ToS byte. DSCP Marking allows users to classify traffic based on DSCP value and send packets to next Router. See Table 4. Here is the DSCP Mapping Table:

Table 4: DSCP Mapping Table

DSCP Mapping Table	
(Wireless) ADSL Router	Standard DSCP
Disabled	None
Best Effort	Best Effort (000000)
Premium	Express Forwarding (101110)
Gold service (L)	Class 1, Gold (001010)
Gold service (M)	Class 1, Silver (001100)
Gold service (H)	Class 1, Bronze (001110)
Silver service (L)	Class 2, Gold (010010)
Silver service (M)	Class 2, Silver (010100)
Silver service (H)	Class 2, Bronze (010110)
Bronze service (L)	Class 3, Gold (011010)
Bronze service (M)	Class 3, Silver (011100)
Bronze service (H)	Class 3, Bronze (011110)

Outbound IP Throttling (LAN to WAN)

IP Throttling allows you to limit the speed of IP traffic. The value entered will limit the speed of the application that you set to the specified value's multiple of 32kbps.

Outbound IP Throttling						
Configuration (from LAN to WAN packet)						
Application	Time Schedule	Protocol	Source Port	Source IP Address Range ('0.0.0.0' means Any)		Rate Limit
			Destination Port	Destination IP Address Range ('0.0.0.0' means Any)		
PPTP	Always On	gre	0 ~ 0	0.0.0.0	~ 0.0.0.0	6 *32 (kbps)
VoIP	Always On	any	0 ~ 0	0.0.0.0	~ 0.0.0.0	4 *32 (kbps)
Restricted	TimeSlot1	any	0 ~ 0	192.168.1.100	~ 192.168.1.100	5 *32 (kbps)
Others	TimeSlot1	any	0 ~ 0	192.168.1.2	~ 192.168.1.5	14 *32 (kbps)
	Always On	any	0 ~ 0	0.0.0.0	~ 0.0.0.0	1 *32 (kbps)
	Always On	any	0 ~ 0	0.0.0.0	~ 0.0.0.0	1 *32 (kbps)
	Always On	any	0 ~ 0	0.0.0.0	~ 0.0.0.0	1 *32 (kbps)
	Always On	any	0 ~ 0	0.0.0.0	~ 0.0.0.0	1 *32 (kbps)

Application: A user-define description to identify this new policy/application.

Time Schedule: Scheduling your prioritization policy. Refer to **Time Schedule** for more information.

Protocol: The name of supported protocol.

Source Port: The source port of packets to be monitored.

Destination Port: The destination port of packets to be monitored.

Source IP Address Range: The source IP address or range of packets to be monitored.

Destination IP address Range: The destination IP address or range of packets to be monitored.

Outbound Rate Limit: To limit the speed of outbound traffic

Inbound IP Throttling (WAN to LAN)

IP Throttling allows you to limit the speed of IP traffic. The value entered will limit the speed of the application that you set to the specified value's multiple of 32kbps.

Inbound IP Throttling						
Configuration (from WAN to LAN packet)						
Application	Time Schedule	Protocol	Source Port	Source IP Address Range ('0.0.0.0' means Any)		Rate Limit
			Destination Port	Destination IP Address Range ('0.0.0.0' means Any)		
Restricted	TimeSlot1	any	0 ~ 0	0.0.0.0	~ 0.0.0.0	64 *32 (kbps)
	Always On	any	0 ~ 0	192.168.1.100	~ 192.168.1.100	1 *32 (kbps)
	Always On	any	0 ~ 0	0.0.0.0	~ 0.0.0.0	1 *32 (kbps)
	Always On	any	0 ~ 0	0.0.0.0	~ 0.0.0.0	1 *32 (kbps)
	Always On	any	0 ~ 0	0.0.0.0	~ 0.0.0.0	1 *32 (kbps)
	Always On	any	0 ~ 0	0.0.0.0	~ 0.0.0.0	1 *32 (kbps)
	Always On	any	0 ~ 0	0.0.0.0	~ 0.0.0.0	1 *32 (kbps)
	Always On	any	0 ~ 0	0.0.0.0	~ 0.0.0.0	1 *32 (kbps)
	Always On	any	0 ~ 0	0.0.0.0	~ 0.0.0.0	1 *32 (kbps)

Application: A user-define description to identify this new policy/application.

Time Schedule: Scheduling your prioritization policy. Refer to **Time Schedule** for more information.

Protocol: The name of supported protocol.

Source Port: The source port of packets to be monitored.

Destination Port: The destination port of packets to be monitored.

Source IP Address Range: The source IP address or range of packets to be monitored.

Destination IP address Range: The destination IP address or range of packets to be monitored.

Inbound Rate Limit: To limit the speed of for inbound traffic.

Example: QoS for your Network

Connection Diagram

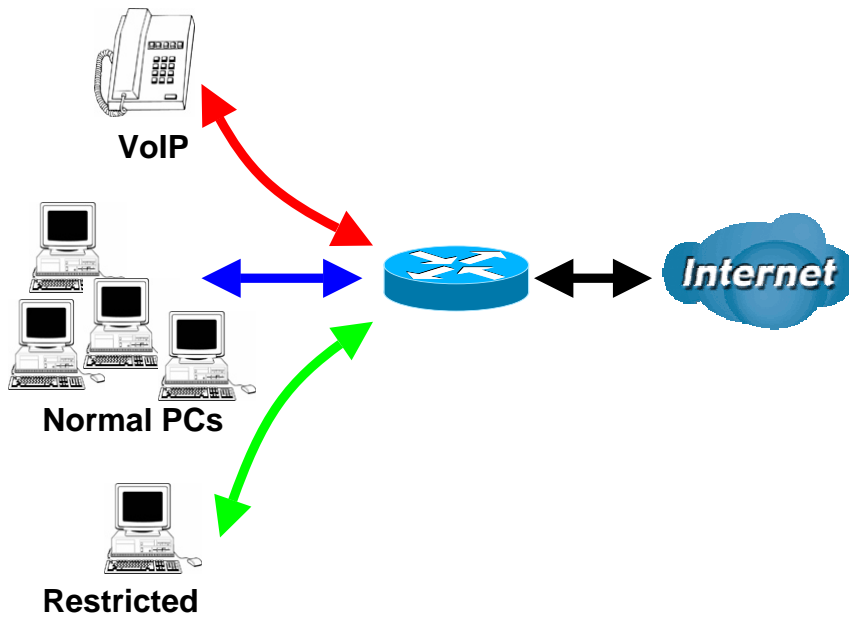

Information and Settings

Upstream: 928 kbps
Downstream: 8 Mbps

VoIP User : 192.168.1.1
Normal Users : 192.168.1.2~192.168.1.5
Restricted User: 192.168.1.100

Prioritization

Configuration (from LAN to WAN packet)

Application	Time Schedule	Priority	Protocol	Source Port	Source IP Address Range (*0.0.0.0* means Any)	DSCP Marking
				Destination Port	Destination IP Address Range (*0.0.0.0* means Any)	
PPTP	Always On	High	GRE	none	0.0.0.0 ~ 0.0.0.0	Gold service (L)
VoIP	Always On	High	any	0 ~ 0	192.168.1.1 ~ 192.168.1.1	Gold service (L)
Restricted	TimeSlot1	Low	any	0 ~ 0	192.168.1.100 ~ 192.168.1.100	Gold service (L)
				0 ~ 0	0.0.0.0 ~ 0.0.0.0	

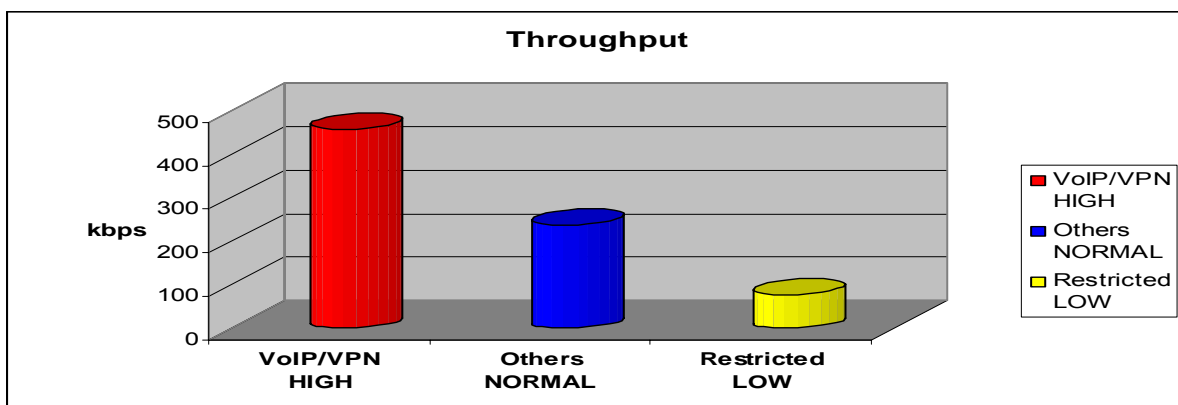

Mission-critical application

The mission-critical application must be sent out smoothly without any dropping. Set priority as high level for preventing any other applications to saturate the bandwidth.

Voice application

Voice is latency-sensitive application. Most VoIP devices are use SIP protocol and the port number will be assigned by SIP module automatically. Better to use fixed IP address for catching VoIP packets as high priority.

VoIP	Always On	High	any	0 ~ 0	192.168.1.1 ~ 192.168.1.1	Gold service (L)
				0 ~ 0	0.0.0.0 ~ 0.0.0.0	

Above settings will help to improve quality of your VoIP service when traffic is full loading.

Restricted Application

Some of companies will setup FTP server for customer downloading or home user sharing their files by using FTP.

Restricted	TimeSlot1	Low	any	0 ~ 0	192.168.1.100 ~ 192.168.1.100	Gold service (L)
				0 ~ 0	0.0.0.0 ~ 0.0.0.0	

With above settings that help to limit utilization of upstream of FTP. Time schedule also help you to only limit utilization at daytime.

Advanced setting by using IP throttling

With IP throttling you can specify more detail for allocating bandwidth; even the applications are located in the same level.

Upstream: 928kbps (29*32kbps)
 Mission-critical Application: 192kbps (6*32kbps)
 Voice Application: 128kbps (4*32kbps)
 Restricted Application: 160kbps (5*32kbps)
 Other Applications: 448kbps (14*32kbps)

$6+4+14+5=29$, $29*32\text{kbps}=928\text{kbps}$

Outbound IP Throttling

Configuration (from LAN to WAN packet)

Application	Time Schedule	Protocol	Source Port	Source IP Address Range (*0.0.0.0* means Any)	Rate Limit
			Destination Port	Destination IP Address Range (*0.0.0.0* means Any)	
PPTP	Always On	gre	0 ~ 0	0.0.0.0 ~ 0.0.0.0	6 *32 (kbps)
			0 ~ 0	0.0.0.0 ~ 0.0.0.0	
VoIP	Always On	any	0 ~ 0	0.0.0.0 ~ 0.0.0.0	4 *32 (kbps)
			0 ~ 0	0.0.0.0 ~ 0.0.0.0	
Restricted	TimeSlot1	any	0 ~ 0	192.168.1.100 ~ 192.168.1.100	5 *32 (kbps)
			0 ~ 0	0.0.0.0 ~ 0.0.0.0	
Others	TimeSlot1	any	0 ~ 0	192.168.1.2 ~ 192.168.1.5	14 *32 (kbps)
			0 ~ 0	0.0.0.0 ~ 0.0.0.0	

Sometime your customers or friends may upload their files to your FTP server and that will saturate your downstream bandwidth. The settings below help you to limit bandwidth for the restricted application.

Inbound IP Throttling

Configuration (from WAN to LAN packet)

Application	Time Schedule	Protocol	Source Port	Source IP Address Range (*0.0.0.0* means Any)	Rate Limit
			Destination Port	Destination IP Address Range (*0.0.0.0* means Any)	
Restricted	TimeSlot1	any	0 ~ 0	0.0.0.0 ~ 0.0.0.0	64 *32 (kbps)
			0 ~ 0	192.168.1.100 ~ 192.168.1.100	

Virtual Server (“Port Forwarding”)

In TCP/IP and UDP networks a port is a 16-bit number used to identify which application program (usually a server) incoming connections should be delivered to. Some ports have numbers that are pre-assigned to them by the IANA (the Internet Assigned Numbers Authority), and these are referred to as “well-known ports”. Servers follow the well-known port assignments so clients can locate them.

If you wish to run a server on your network that can be accessed from the WAN (i.e. from other machines on the Internet that are outside your local network), or any application that can accept incoming connections (e.g. Peer-to-peer/P2P software such as instant messaging applications and P2P file-sharing applications) and are using NAT (Network Address Translation), then you will usually need to configure your router to forward these incoming connection attempts using specific ports to the PC on your network running the application. You will also need to use port forwarding if you want to host an online game server.

The reason for this is that when using NAT, your publicly accessible IP address will be used by and point to your router, which then needs to deliver all traffic to the private IP addresses used by your PCs. Please see the **WAN** configuration section of this manual for more information on NAT.

The device can be configured as a virtual server so that remote users accessing services such as Web or FTP services via the public (WAN) IP address can be automatically redirected to local servers in the LAN network. Depending on the requested service (TCP/UDP port number), the device redirects the external service request to the appropriate server within the LAN network

Virtual Server (Port Forwarding)

[Add Virtual Server ▶](#)
[Edit DMZ Host ▶](#)
[Edit One-to-one NAT ▶](#)

Virtual Server Table

Application	Time Schedule	Protocol	External Port	Redirect Port	IP Address		

Add Virtual Server

Because NAT can act as a “natural” Internet firewall, your router protects your network from being accessed by outside users when using NAT, as all incoming connection attempts will point to your router unless you specifically create Virtual Server entries to forward those ports to a PC on your network.

When your router needs to allow outside users to access internal servers, e.g. a web server, FTP server, Email server or game server, the router can act as a “virtual server”. You can set up a local server with a specific port number for the service to use, e.g. web/HTTP (port 80), FTP (port 21), Telnet (port 23), SMTP (port 25), or POP3 (port 110), When an incoming access request to the router for a specified port is received, it will be forwarded to the corresponding internal server.

Virtual Server (Port Forwarding)

Add Virtual Server ▶
Edit DMZ Host ▶
Edit One-to-one NAT ▶

Virtual Server Table					
Application	Time Schedule	Protocol	External Port	Redirect Port	IP Address

Add Virtual Server in 'ipwan' IP Interface

Virtual Server Entry

Time Schedule	Always On ▼
Application Helper ▶	<input style="width: 100%;" type="text"/>
Protocol	tcp ▼
External Port	from <input style="width: 40px;" type="text" value="0"/> to <input style="width: 40px;" type="text" value="0"/>
Redirect Port	from <input style="width: 40px;" type="text" value="0"/> to <input style="width: 40px;" type="text" value="0"/>
Internal IP Address Candidates ▶	<input style="width: 100%;" type="text"/>

Apply
Return ▶

Time Schedule: A self-defined time period to enable your virtual server. You may specify a time schedule or Always on for the usage of this Virtual Server Entry. For setup and detail, refer to **Time Schedule** section

Application: Users-define description to identify this entry or click Helper ▶ to select existing predefined rules.

Helper ▶: 20 predefined rules are available. Click the Radio button to select the rule; Application, Protocol and External/Redirect Ports will be filled after the selection.

Protocol: It is the supported protocol for the virtual server. In addition to specifying the port number to be used, you will also need to specify the protocol used. The protocol used is determined by the particular application. Most applications will use TCP or UDP.

External Port: The Port number on the Remote/WAN side used when accessing the virtual server.

Redirect Port: The Port number used by the Local server in the LAN network.

Internal IP Address: The private IP in the LAN network, which will be providing the virtual server application. **Candidates** List all existing PCs connecting to the network. You may assign a PC with IP address and MAC from this list.

Example:

If you like to remote accessing your Router through the Web/HTTP at all time, you would need to enable port number 80 (Web/HTTP) and map to Router's IP Address. Then all incoming HTTP requests from you (Remote side) will be forwarded to the Router with IP address of 192.168.1.254. Since port number 80 has already been predefined, next to the **Application** click **Helper**. A list of predefined rules window will pop and select **HTTP_Server**.

Application: *HTTP_Server*
 Time Schedule: *Always On*
 Protocol: *tcp*
 External Port: *80-80*
 Redirect Port: *80-80*
 IP Address: *192.168.1.254*

Virtual Server (Port Forwarding)							
Add Virtual Server		Edit DMZ Host		Edit One-to-one NAT			
Virtual Server Table							
Application	Time Schedule	Protocol	External Port	Redirect Port	IP Address		
HTTP_Server	Always On	tcp	80 - 80	80 - 80	192.168.1.254	Edit	Delete

Edit: Click it to edit this virtual server application.

Delete: Click it to delete this virtual server application.



Using port forwarding does have security implications, as outside users will be able to connect to PCs on your network. For this reason you are advised to use specific Virtual Server entries just for the ports your application requires, instead of using DMZ. As doing so will result in all connections from the WAN attempt to access to your public IP of the DMZ PC specified.



Attention

If you have disabled the NAT option in the WAN-ISP section, the Virtual Server function will hence be invalid.

If the DHCP server option is enabled, you have to be very careful in assigning the IP addresses of the virtual servers in order to avoid conflicts. The easiest way of configuring Virtual Servers is to manually assign static IP address to each virtual server PC, with an address that does not fall into the range of IP addresses that are to be issued by the DHCP server. You can configure the virtual server IP address manually, but it must still be in the same subnet as the router.

Edit DMZ Host

The DMZ Host is a local computer exposed to the Internet. When setting a particular internal IP address as the DMZ Host, all incoming packets will be checked by the Firewall and NAT algorithms then passed to the DMZ host, when a packet received does not use a port number used by any other Virtual Server entries.

Caution: This Local computer exposing to the Internet may face varies of security risks.

Virtual Server (Port Forwarding)

Add Virtual Server ▶
Edit DMZ Host ▶
Edit One-to-one NAT ▶

Application	Time Schedule	Protocol	External Port	Redirect Port	IP Address
<h3 style="margin: 0;">Edit DMZ Host</h3> <p style="margin: 0;">DMZ Host for 'ipwan' IP Interface</p> <p style="margin: 0;"> <input type="radio"/> Enabled <input checked="" type="radio"/> Disabled </p> <p style="margin: 0;"> Internal IP Address Candidates ▶ <input style="width: 150px; height: 20px; margin-left: 10px;" type="text"/> </p> <p style="margin: 0;"> <input type="button" value="Apply"/> <input type="button" value="Return"/> </p>					

Disabled: As set in default setting, it disables the DMZ function.

Enabled: It activates your DMZ function.

Internal IP Address: Give a static IP address to the DMZ Host when **Enabled** radio button is checked. Be aware that this IP will be exposed to the WAN/Internet.

Candidates ▶ Listed all existing PCs connecting to the network. You may assign a PC with IP address and MAC from this list.

Select the **Apply** button to apply your changes.

Edit One-to-One NAT (Network Address Translation)

One-to-One NAT maps a specific private/local IP address to a global/public IP address.

If you have multiple public/WAN IP addresses from you ISP, you are eligible for One-to-One NAT to utilize these IP addresses.

Virtual Server (Port Forwarding)

Add Virtual Server ▶
Edit DMZ Host ▶
Edit One-to-one NAT ▶

Virtual Server Table

Application	Time Schedule	Protocol	External Port	Redirect Port	IP Address

Global IP Pool in 'ipwan' IP interface

Global Address Pool

NAT Type	<input checked="" type="radio"/> Disable <input type="radio"/> Public to Private Subnet <input type="radio"/> Public to DMZ Zone				
Global IP Addresses	<input checked="" type="radio"/> Subnet	IP Address		Netmask	
	<input type="radio"/> IP Range	IP Address		End IP	

Apply
Return ▶

One-to-one NAT Table [Add Entry ▶](#)

Application	Time Schedule	Protocol	External Port	Redirect Port	IP Address

NAT Type: Select desired NAT type. As set in default setting, it disables the One-to-One NAT function.

Global IP Address:

Subnet: The subnet of the public/WAN IP address given by your ISP. If your ISP has provided this information, you may insert it here. Otherwise, use IP Range method.

IP Range: The IP address range of your public/WAN IP addresses. For example, IP: 192.168.1.1, end IP: 192.168.1.10

Select the **Apply** button to apply your changes.

Check [Add Entry ▶](#) to create a new One-to-One NAT rule:

Add Virtual Server in 'ipwan' IP interface

Virtual Server Entry	
Time Schedule	Always On ▾
Application Helper ▶	<input type="text"/>
Protocol	tcp ▾
Global IP	<input type="text"/>
External Port	from <input type="text" value="0"/> to <input type="text" value="0"/>
Redirect Port	from <input type="text" value="0"/> to <input type="text" value="0"/>
Internal IP Address Candidates ▶	<input type="text"/>

Time Schedule: A self-defined time period to enable your virtual server. You may specify a time schedule or Always on for the usage of this Virtual Server Entry. For setup and detail, refer to **Time Schedule** section

Application: Users-defined description to identify this entry or click [Helper ▶](#) to select existing predefined rules.

[Helper ▶](#): 20 predefined rules are available. Click the Radio button to select the rule; Application, Protocol and External/Redirect Ports will be filled after the selection.

Protocol: It is the supported protocol for the virtual server. In addition to specifying the port number to be used, you will also need to specify the protocol used. The protocol used is determined by the particular application. Most applications will use TCP or UDP;

Global IP: Define a public/ WAN IP address for this Application to use. This Global IP address must be defined in the **Global IP Address**.

External Port: The Port number on the Remote/WAN side used when accessing the virtual server.

Redirect Port: The Port number used by the Local server in the LAN network.

Internal IP Address: The private IP in the LAN network, which will be providing the virtual server application. [Candidates ▶](#) List all existing PCs connecting to the network. You may assign a PC with IP address and MAC from this list.

Select the **Apply** button to apply your changes.

Example: List of some well-known and registered port numbers.

The Internet Assigned Numbers Authority (IANA) is the central coordinator for the assignment of unique parameter values for Internet protocols. Port numbers range from 0 to 65535, but only ports numbers 0 to 1023 are reserved for privileged services and are designated as “well-known ports” (Please refer to Table 5). The registered ports are numbered from 1024 through 49151. The remaining ports, referred to as dynamic or private ports, are numbered from 49152 through 65535.

For further information, please see IANA’s website at: <http://www.iana.org/assignments/port-numbers>

For help on determining which private port numbers are used by common applications on this list, please see the FAQs (Frequently Asked Questions) at: <http://www.billion.com>

Table 5: Well-known and registered Ports

Port Number	Protocol	Description
20	TCP	FTP Data
21	TCP	FTP Control
22	TCP & UDP	SSH Remote Login Protocol
23	TCP	Telnet
25	TCP	SMTP (Simple Mail Transfer Protocol)
53	TCP & UDP	DNS (Domain Name Server)
69	UDP	TFTP (Trivial File Transfer Protocol)
80	TCP	World Wide Web HTTP
110	TCP	POP3 (Post Office Protocol Version 3)
119	TCP	NEWS (Network News Transfer Protocol)
123	UDP	NTP (Network Time Protocol)
161	TCP	SNMP
443	TCP & UDP	HTTPS
1503	TCP	T.120
1720	TCP	H.323
4000	TCP	ICQ
7070	UDP	RealAudio

Time Schedule

The Time Schedule supports up to 16 time slots which helps you to manage your Internet connection. In each time profile, you may schedule specific day(s) i.e. Monday through Sunday to restrict or allowing the usage of the Internet by users or applications.

This Time Schedule correlates closely with router's time, since router does not have a real time clock on board; it uses the Simple Network Time Protocol (SNTP) to get the current time from an SNTP server from the Internet. Refer to **Time Zone** for details. Your router time should correspond with your local time. If the time is not set correctly, your Time Schedule will not function properly.

Time Schedule						
Time Slot						
ID	Name	Day in a week	Start Time	End Time		
1	TimeSlot1	sMTWTFs	08 : 00	18 : 00	Edit	Clear
2	TimeSlot2	sMTWTFs	08 : 00	18 : 00	Edit	Clear
3	TimeSlot3	sMTWTFs	08 : 00	18 : 00	Edit	Clear
4	TimeSlot4	sMTWTFs	08 : 00	18 : 00	Edit	Clear
5	TimeSlot5	sMTWTFs	08 : 00	18 : 00	Edit	Clear
6	TimeSlot6	sMTWTFs	08 : 00	18 : 00	Edit	Clear
7	TimeSlot7	sMTWTFs	08 : 00	18 : 00	Edit	Clear
8	TimeSlot8	sMTWTFs	08 : 00	18 : 00	Edit	Clear
9	TimeSlot9	sMTWTFs	08 : 00	18 : 00	Edit	Clear
10	TimeSlot10	sMTWTFs	08 : 00	18 : 00	Edit	Clear
11	TimeSlot11	sMTWTFs	08 : 00	18 : 00	Edit	Clear
12	TimeSlot12	sMTWTFs	08 : 00	18 : 00	Edit	Clear
13	TimeSlot13	sMTWTFs	08 : 00	18 : 00	Edit	Clear
14	TimeSlot14	sMTWTFs	08 : 00	18 : 00	Edit	Clear
15	TimeSlot15	sMTWTFs	08 : 00	18 : 00	Edit	Clear
16	TimeSlot16	sMTWTFs	08 : 00	18 : 00	Edit	Clear

Configuration of Time Schedule

Edit a Time Slot

1. Choose any Time Slot (ID 1 to ID 16) to edit, click **Edit**.

Time Schedule						
Time Slot						
ID	Name	Day in a week	Start Time	End Time		
1	TimeSlot1	sMTWTFs	08 : 00	18 : 00	Edit	Clear
2	TimeSlot2	sMTWTFs	08 : 00	18 : 00	Edit	Clear

Click Edit

Note: Watch it carefully, the days you have selected will present in capital letter. Lower case letter shows the day(s) is not selected, and no rule will apply on this day(s).

2. A detailed setting of this Time Slot will be shown.

Time Schedule	
Edit Time Slot	
ID	1
Name	<input type="text" value="TimeSlot1"/>
Day	<input type="checkbox"/> Sun. <input checked="" type="checkbox"/> Mon. <input checked="" type="checkbox"/> Tue <input checked="" type="checkbox"/> Wed <input checked="" type="checkbox"/> Thu <input checked="" type="checkbox"/> Fri. <input type="checkbox"/> Sat.
Start Time	08 : 00
End Time	18 : 00
<input type="button" value="Apply"/>	

ID: This is the index of the time slot.

Name: A user-define description to identify this time portfolio.

Day: The default is set from Monday through Friday. You may specify the days for the schedule to be applied.

Start Time: The default is set at 8:00 AM. You may specify the start time of the schedule.

End Time: The default is set at 18:00 (6:00PM). You may specify the end time of the schedule.

Select the **Apply** button to apply your changes.

Delete a Time Slot

Click **Clear** to delete the existing Time profile, i.e. erase the Day and back to default setting of Start Time / End Time.

Advanced

Configuration options within the **Advanced** section are for users who wish to take advantage of the more advanced features of the router. Users who do not understand the features should not attempt to reconfigure their router, unless advised to do so by support staff.

There are four items within the **Advanced** section: [Static Route](#), [Dynamic DNS](#), [Check Email](#), [Device Management](#) and [IGMP](#).

Static Route

Click on **Routing Table** and then choose **Create Route** add a routing table.

Static Route			
Create			
Destination	<input type="text"/>		
Netmask	<input type="text"/>		
via Gateway	<input type="text"/>	or Interface	<input type="text" value="v"/>
Cost	<input type="text" value="1"/>		
<input type="button" value="Apply"/> <input type="button" value="Cancel"/>			

Destination: This is the destination subnet IP address.

Netmask: Subnet mask of the destination IP addresses based on above destination subnet IP.

Gateway: This is the gateway IP address to which packets are to be forwarded.

Interface: Select the interface through which packets are to be forwarded.

Cost: This is the same meaning as Hop. This should usually be left at 1.

Dynamic DNS

Dynamic DNS	
Parameters	
Dynamic DNS	<input type="radio"/> Enable <input checked="" type="radio"/> Disable
Dynamic DNS Server	www.dyndns.org (dynamic) ▾
Domain Name	<input type="text"/>
Username	<input type="text"/>
Password	<input type="text"/>
Period	25 <input type="text"/> Day(s) ▾
<input type="button" value="Apply"/> <input type="button" value="Cancel"/>	

The Dynamic DNS function allows you to alias a dynamic IP address to a static hostname, allowing users whose ISP does not assign them a static IP address to use a domain name. This is especially useful for hosting servers via your ADSL connection, so that anyone wishing to connect to you may use your domain name, rather than having to use your dynamic IP address, which changes from time to time. This dynamic IP address is the WAN IP address of the router, which is assigned to you by your ISP.

You will first need to register and establish an account with the Dynamic DNS provider using their website, for example <http://www.dyndns.org/>

There are more than 5 DDNS services supported.

⊙ Disable: Check to disable the Dynamic DNS function.

⊙ Enable: Check to enable the Dynamic DNS function. The following fields will be activated and required:

Dynamic DNS Server: Select the DDNS service you have established an account with.

Domain Name, Username and Password: Enter your registered domain name and your username and password for this service.

Period: Set the time period between updates, for the Router to exchange information with the DDNS server. In addition to updating periodically as per your settings, the router will perform an update when your dynamic IP address changes.

Via WAN Interface: Decide which WAN interface you want to use for sending DDNS request.

Check Email

Check Email	
Parameters	
Check Email	<input type="radio"/> Enable <input checked="" type="radio"/> Disable
Account Name	<input type="text"/>
Password	<input type="text"/>
POP3 Mail Server	<input type="text"/>
Period	<input type="text" value="60"/> minutes
Dial-out for Checking Emails	<input type="checkbox"/> Automatic
<input type="button" value="Apply"/>	

This function allows you to have the router check your POP3 mailbox for new Email messages. The **Mail** LED on your router will light when it detects new messages waiting for download. You may also view the status of this function using the **Status – Email Checking** section of the web interface, which also provides details on the number of new messages waiting. See the **Status** section of this manual for more information.

Disable: Check to disable the router's Email checking function.

Enable: Check to enable the routers Emailing checking function. The following fields will be activated and required:

Account Name: Enter the name (login) of the POP3 account you wish to check.. Normally, it is the text in your email address before the "@" symbol. If you have trouble with it, please contact your ISP.

Password: Enter the account's password.

POP3 Mail Server: Enter your (POP) mail server name. Your Internet Service Provider (ISP) or network administrator will be able to supply you with this.

Interval: Enter the value in minutes between periodic mail checks.

Automatically dial-out for checking emails: When the function is enabled, your ADSL router will connect to your ISP automatically to check emails if your Internet connection dropped. Please be careful when using this feature if your ADSL service is charged by time online.

Device Management

The Device Management advanced configuration settings allow you to control your router's security options and device monitoring features.

Device Management			
Device Host Name			
Host Name	<input type="text" value="home.gateway"/>		
Embedded Web Server			
* HTTP Port	<input type="text" value="80"/>	(80 is default HTTP port)	
Management IP Address	<input type="text" value="0.0.0.0"/>	(0.0.0.0 means Any)	
Expire to auto-logout	<input type="text" value="180"/>	seconds	
Universal Plug and Play (UPnP)			
UPnP	<input checked="" type="radio"/> Enable <input type="radio"/> Disable		
* UPnP Port	<input type="text" value="2800"/>		
SNMP Access Control			
SNMP V1 and V2			
Read Community	<input type="text" value="public"/>	IP Address	<input type="text" value="0.0.0.0"/>
Write Community	<input type="text" value="password"/>	IP Address	<input type="text" value="0.0.0.0"/>
Trap Community	<input type="text"/>	IP Address	<input type="text"/>
SNMP V3			
Username	<input type="text"/>	Password	<input type="text"/>
Access Right	<input checked="" type="radio"/> Read <input type="radio"/> Read/Write	IP Address	<input type="text"/>
* : This setting will become effective after you save to flash and restart the router.			
<input type="button" value="Apply"/>			

Embedded Web Server

HTTP Port: This is the port number the router's embedded web server (for web-based configuration) will use. The default value is the standard HTTP port, 80. Users may specify an alternative if, for example, they are running a web server on a PC within their LAN.

Management IP Address: You may specify an IP address allowed to logon and access the router's web server. Setting the IP address to 0.0.0.0 will disable IP address restrictions, allowing users to logon from any IP address.

Expire to auto-logout: Specify a time frame for the system to auto-logout the user's configuration session.

For Example: User A changes HTTP port number to **100**, specifies their own IP address of **192.168.1.55**, and sets the logout time to be **100** seconds. The router will only allow User A access from the IP address **192.168.1.55** to logon to the Web GUI by typing: <http://192.168.1.254:100> in their web browser. After 100 seconds, the device will automatically logout User A.

Universal Plug and Play (UPnP)

UPnP offers peer-to-peer network connectivity for PCs and other network devices, along with control and data transfer between devices. UPnP offers many advantages for users running NAT routers through UPnP NAT Traversal, and on supported systems makes tasks such as port forwarding much easier by letting the application control the required settings, removing the need for the user to control advanced configuration of their device.

Both the user's Operating System and the relevant application must support UPnP in addition to the router. Windows XP and Windows Me natively support UPnP (when the component is installed), and Windows 98 users may install the Internet Connection Sharing client from Windows XP in order to support UPnP. Windows 2000 does not support UPnP.

⊙ **Disable:** Check to disable the router's UPnP functionality.

⊙ **Enable:** Check to enable the router's UPnP functionality.

UPnP Port: Its default setting is 2800. It is highly recommended for users to use this port value. If this value conflicts with other ports already being used you may wish to change the port.

SNMP Access Control (Software on a PC within the LAN is required in order to utilize this function) – Simple Network Management Protocol.

SNMP V1 and V2:

Read Community: Specify a name to be identified as the Read Community, and an IP address. This community string will be checked against the string entered in the configuration file. Once the string name is matched, user obtains this IP address will be able to view the data.

Write Community: Specify a name to be identified as the Write Community, and an IP address. This community string will be checked against the string entered in the configuration file. Once the string name is matched, users from this IP address will be able to view and modify the data.

Trap Community: Specify a name to be identified as the Trap Community, and an IP address. This community string will be checked against the string entered in the configuration file. Once the string name is matched, users from this IP address will be sent SNMP Traps.

SNMP V3:

Specify a name and password for authentication. And define the access right from identified IP address. Once the authentication has succeeded, users from this IP address will be able to view and modify the data.

SNMP Version: SNMPv2c and SNMPv3

SNMPv2c is the combination of the enhanced protocol features of SNMPv2 without the SNMPv2 security. The "c" comes from the fact that SNMPv2c uses the SNMPv1 community string paradigm for "security", but is widely accepted as the SNMPv2 standard.

SNMPv3 is a strong authentication mechanism, authorization with fine granularity for remote monitoring.

Traps supported: Cold Start, Authentication Failure.

The following MIBs are supported:

- **From RFC 1213 (MIB-II):**
 - System group
 - Interfaces group
 - Address Translation group
 - IP group
 - ICMP group
 - TCP group
 - UDP group
 - EGP (not applicable)
 - Transmission
 - SNMP group

- **From RFC1650 (EtherLike-MIB):**
 - dot3Stats

- **From RFC 1493 (Bridge MIB):**
 - dot1dBase group
 - dot1dTp group
 - dot1dStp group (if configured as spanning tree)

- **From RFC 1471 (PPP/LCP MIB):**
 - pppLink group
 - pppLqr group

- **From RFC 1472 (PPP/Security MIB):**
 - PPP Security Group)

➤ **From RFC 1473 (PPP/IP MIB):**

PPP IP Group

➤ **From RFC 1474 (PPP/Bridge MIB):**

PPP Bridge Group

➤ **From RFC1573 (IfMIB):**

ifMIBObjects Group

➤ **From RFC1695 (atmMIB):**

atmMIBObjects

➤ **From RFC 1907 (SNMPv2):**

only snmpSetSerialNo OID

IGMP

IGMP, known as *Internet Group Management Protocol*, is used to management hosts from multicast group.

IGMP	
Parameters	
IGMP Forwarding	<input checked="" type="radio"/> Enable <input type="radio"/> Disable
IGMP Snooping	<input checked="" type="radio"/> Enable <input type="radio"/> Disable
<input type="button" value="Apply"/>	

IGMP Forwarding: Accepting multicast packet. Default is set to **Enable**.

IGMP Snooping: Allowing switched Ethernet to check and make correct forwarding decisions. Default is set to **Enable**

Save Configuration to Flash

After changing the router's configuration settings, you must save all of the configuration parameters to FLASH to avoid them being lost after turning off or resetting your router. Click **Save** to write your new configuration to FLASH.

Save Config to FLASH

Please confirm that you wish to save the configuration.

There will be a delay while saving as configuration information is written to FLASH chips.

Logout

To exit the router's web interface, choose **Logout**. Please ensure that you have saved the configuration settings before you logout.

Be aware that the router is restricted to only one PC accessing the configuration web pages at a time. Once a PC has logged into the web interface, other PCs cannot get access until the current PC has logged out of the web interface. If the previous PC forgets to logout, the second PC can access the page after a user-defined period, by default 3 minutes. You can modify this value using the **Advanced – Device Management** section of the web interface. Please see the **Advanced** section of this manual for more information.

Chapter 5: Troubleshooting

If the router is not functioning properly, first check this chapter for simple troubleshooting before contacting your service provider or Billion support.

Problems starting up the router

Problem	Corrective Action
None of the LEDs are on when you turn on the router.	Check the connection between the adapter and the router. If the error persists, you may have a hardware problem. In this case you should contact technical support.
You have forgotten your router login and/or password.	Try the default login and password, refer to Chapter 3. If this fails, you can restore your router to its factory settings by holding the Reset button on the back of your router more than 6 seconds.

Problems with the WAN Interface

Problem	Corrective Action
Initialization of the PVC connection (“linesync”) failed.	Ensure that the telephone cable is connected properly from the ADSL port to the wall jack. The ADSL LED on the front panel of the router should be on. Check that your VPI, VCI, encapsulation type and type of multiplexing settings are the same as those provided by your ISP. Reboot the router GE. If you still have problems, you may need to verify these settings with your ISP.
Frequent loss of ADSL linesync (disconnections).	Ensure that all other devices connected to the same telephone line as your router (e.g. telephones, fax machines, analogue modems) have a line filter connected between them and the wall socket (unless you are using a Central Splitter or Central Filter installed by a qualified and licensed electrician), and ensure that all line filters are correctly installed and the right way around. Missing line filters or line filters installed the wrong way around can cause problems with your ADSL connection, including causing frequent disconnections.

Problems with the LAN Interface

Problem	Corrective Action
Can't ping any PCs on the LAN.	Check the Ethernet LEDs on the front panel. The LED should be on for a port that has a PC connected. If it is off, check the cables between your router and the PC. Make sure you have uninstalled any software firewall for troubleshooting.
	Verify that the IP address and the subnet mask are consistent between the router and the workstations.

APPENDIX A: Product Support and Contact Information

Most problems can be solved by referring to the **Troubleshooting** section in the User's Manual. If you cannot resolve the problem with the **Troubleshooting** chapter, please contact the dealer where you purchased this product.

Contact Billion

AUSTRALIA

<http://www.billion.com.au/>

©2005 Billion Electric Co., Ltd. PC Range P/L. All Rights Reserved.

WORLDWIDE

<http://www.billion.com/>

Mac OS is a registered Trademark of Apple Computer, Inc.
Windows 98, Windows NT, Windows 2000, Windows Me and Windows XP are registered Trademarks of Microsoft Corporation.